

---

# **CHESAPEAKE BAY WATERSHED MODEL APPLICATION AND CALCULATION OF NUTRIENT AND SEDIMENT LOADINGS**

## **Appendix H: Tracking Best Management Practice Nutrient Reductions in the Chesapeake Bay Program**

---

A Report of the  
Chesapeake Bay Program  
Modeling Subcommittee  
Annapolis, MD

August 1998



**Chesapeake Bay Program**

Printed by the U.S. Environmental Protection Agency for the Chesapeake Bay Program

---

## Principal Authors

---

Michael W. Palace  
Chesapeake Research Consortium  
Chesapeake Bay Program Office  
Annapolis, MD

James E. Hannawald  
United States Department of Agriculture  
Natural Resources Conservation Service  
Chesapeake Bay Program Office  
Annapolis, MD

Lewis C. Linker  
United States Environmental Protection Agency  
Chesapeake Bay Program Office  
Annapolis, MD

Gary W. Shenk  
United States Environmental Protection Agency  
Chesapeake Bay Program Office  
Annapolis, MD

Jennifer M. Storrick  
Chesapeake Research Consortium  
Chesapeake Bay Program Office  
Annapolis, MD

Michael L. Clipper  
Chesapeake Research Consortium  
Chesapeake Bay Program Office  
Annapolis, MD

---

## Tributary Strategy Workgroup

---

Tom Simpson  
Chairman  
MD Department of Agriculture  
Chesapeake Bay Agricultural Programs  
Annapolis, MD

Mary Searing  
MD Department of Natural Resources  
Watershed Management and Analysis Division  
Annapolis, MD

Mark Bennett  
VA Dept. of Conservation & Recreation  
Division of Soil and Water Conservation  
Richmond, VA

Mohsin Siddique  
DC Dept. of Health  
Washington, DC

Don Fiesta  
PA Dept. of Environmental Protection  
Bureau of Water Quality Protection  
Harrisburg, PA

Helen Stewart  
MD Dept. of Natural Resources  
Watershed Management and Analysis Division  
Annapolis, MD

Jim Hannawald  
US Dept. of Agriculture  
Natural Resource Conservation Service  
Chesapeake Bay Program Office  
Annapolis, MD

Tom Tapley, Chair, Pt. Source Workgroup  
MD Dept. of the Environment  
Technical and Regulatory Services Administration  
Baltimore, MD

Wayne Jenkins  
MD Dept. of the Environment  
Chesapeake Bay Watershed Management  
Administration  
Baltimore, MD

Allison Wiedeman  
US Environmental Protection Agency  
Chesapeake Bay Program Office  
Annapolis, MD

Tim Karikari  
DC Dept. of Health  
Washington, DC

Kenn Pattison  
PA Dept. of Environmental Protection  
Bureau of Water Quality Protection  
Harrisburg, PA

Russ Mader Jr.  
US Dept. of Agriculture  
Natural Resource Conservation Service  
Chesapeake Bay Program Office  
Annapolis, MD

---

## Modeling Subcommittee Members

---

James R. Collier  
Chairman  
Water Resources Management Division  
Washington, DC

Dr. Joseph Bachman  
US Geological Survey  
Towson, MD

Mark Bennett  
Department of Soil and Water Conservation  
Richmond, VA

Dr. Peter Bergstrom  
Chesapeake Bay Field Office  
US Fish & Wildlife Service  
Annapolis, MD

Dr. Arthur Butt  
Chesapeake Bay Office  
VA Department of Environmental Quality  
Richmond, VA

Brian Hazelwood  
Metropolitan Washington Council of  
Governments  
Washington, DC

Dr. Albert Y. Kuo  
VA Institute of Marine Science  
Gloucester Point, VA

Lewis C. Linker  
Coordinator  
US EPA Chesapeake Bay Program Office  
Annapolis, MD

Dr. Robert Magnien  
MD Department of Natural Resources  
Assessment Administration  
Annapolis, MD

Dr. Ross Mandel  
Interstate Commission on the Potomac  
River Basin  
Rockville, MD

Dr. Bruce Parker  
National Oceanic and Atmospheric  
Administration/NOS/OES33  
Coastal & Estuarine Oceanography  
Silver Spring, MD

Kenn Pattison  
PA Dept. of Environmental Protection  
Bureau of Water Quality Protection  
Harrisburg, PA

Ron Santos  
US Army Corps of Engineers  
Baltimore, MD

Dr. Tom Stockton  
MD Dept. of Environmental Resources  
Watershed Modeling & Analysis  
Annapolis, MD

Paul Welle  
USDA Natural Resources Conservation Service  
East Regional Office  
Beltsville, MD

Dr. Alan Lumb  
Hydrologic Analysis Support Section  
USGS National Center  
Reston, VA

---

## **Acknowledgments**

---

The writers would like to acknowledge the contribution of the Nutrient Subcommittee's Tributary Strategy Workgroup for their guidance in the development and review of this document. This document, and other Chesapeake Bay Program modeling documents, can be found on the Modeling Subcommittee web page:

<http://www.chesapeakebay.net/bayprogram/pol/mdsc/model.htm>

---

## **Appendix Summary**

---

Appendix H documents the work of the Chesapeake Bay Program Nutrient Subcommittee and the Tributary Strategy Workgroup. The Tributary Strategy Workgroup is made up of Chesapeake Bay Program scientists, engineers, and managers who work closely with the Chesapeake Bay Watershed Model in estimating the progress toward Chesapeake Bay nutrient reduction goals. Appendix H provides a summary of the methodologies used in tracking nutrient reduction goals with the Phase IV Watershed Model and outlines the data management procedures used for BMP tracking within each state. Information on nutrient application rates, land use conversions, and the application of land use-based BMP efficiency rates within the Phase IV Watershed Model is presented.

---

## **List of Phase IV Watershed Model Reference Appendices**

---

- Appendix A Phase IV Chesapeake Bay Watershed Model Hydrology Calibration Results
- Appendix B Phase IV Chesapeake Bay Watershed Model Water Quality Calibration
- Appendix C Phase IV Chesapeake Bay Watershed Model Nonpoint Source Simulation
- Appendix D Phase IV Chesapeake Bay Watershed Model Precipitation and Meteorological Data Development and Atmospheric Nutrient Deposition
- Appendix E Phase IV Chesapeake Bay Watershed Land Use & Model Linkages to the Airshed & Estuarine Models
- Appendix F Phase IV Chesapeake Bay Watershed Model Point Source Loads
- Appendix G Observed Water Quality Data Used for Calibration, A Simulation of Regression Loads, and a Confirmation Scenario of the Phase IV Chesapeake Bay Watershed Model
- Appendix H Tracking Best Management Practice Nutrient Reductions in the Chesapeake Bay Program
- Appendix I Model Operations Manual

# Table of Contents

<i>Principal Authors</i> .....	2
<i>Tributary Strategy Workgroup Members</i> .....	3
<i>Modeling Subcommittee Members</i> .....	4
<i>Acknowledgments</i> .....	5
<i>Appendix Summary</i> .....	6
<i>List of Phase IV Watershed Model Reference Appendices</i> .....	7
<i>Table of Contents</i> .....	8
<i>List of Figures</i> .....	10
<i>List of Tables</i> .....	11
<i>Acronym Index</i> .....	13
<b><i>H.1 BMP Data Management</i></b> .....	<b>14</b>
H.1.1 Federal Cost-Share Programs.....	19
H.1.2 State Programs.....	22
H.1.3 Land Use Conversions.....	33
<b><i>H.2 Implementation of Nutrient Management BMP Application Rates and BMP</i></b>	
<b><i>Nutrient Reduction Efficiency Rates</i></b> .....	<b>38</b>
H.2.1 BMPs Involving Land Use Conversion.....	38
H.2.1.1 Conservation Reserve Program.....	39
H.2.1.2 Forest Conservation.....	39
H.2.1.3 Tree Planting.....	39
H.2.1.4 Conservation Tillage.....	39
H.2.1.5 Forest and Grass Buffers.....	41
H.2.2 BMPs Involving Nutrient Reduction Efficiencies.....	43
H.2.2.1 Urban BMPs.....	46
H.2.2.1.1 Erosion and Sediment Controls.....	46
H.2.2.1.2 Stormwater Management Systems.....	47
H.2.2.1.3 Onsite Wastewater Management Systems.....	48
H.2.2.1.4 Onsite Wastewater Management System Loading.....	49
H.2.2.1.5 Urban Nutrient Management.....	56
H.2.2.2 Agriculture/Silviculture BMPs.....	59
H.2.2.2.1 Cropland Nutrient Management.....	59
H.2.2.2.2 Soil Conservation and Water Quality Plan.....	59
H.2.2.2.3 Animal Waste Management Systems.....	61
H.2.2.2.4 Manure Application to Pastureland.....	76
H.2.2.2.5 Runoff Control for Animal Confinement Areas.....	83
H.2.2.2.6 Grazing Land Rotation.....	83
H.2.2.2.7 Stream Protection (with and without fencing).....	83
H.2.2.2.8 Forestry BMPs.....	84
H.2.2.2.9 Forest and Grass Buffers.....	85
H.2.2.2.10 Cover Crops.....	85



H.2.2.3	BMPs Affecting Direct Loads to Tidal Bay Waters.....	85
H.2.2.3.1	Marine Sewage Disposal Facilities.....	85
H.2.2.3.2	Shoreline Protection.....	86
H.2.2.3.3	Combined Sewer Overflows.....	86
<b>H.3</b>	<b><i>Summary of Watershed Model Operations.....</i></b>	<b>87</b>
H.3.1	Scenario Characteristic Modification.....	88
H.3.2	Initial Model Run for the Edge of Stream Loads.....	88
H.3.3	Adjustment of Bed Concentration.....	88
H.3.4	Second Model Run.....	88
H.3.5	Delivery Factors.....	89
H.3.6	Final Model Run.....	89
	<b><i>Reference.....</i></b>	<b>90</b>

## List of Figures

<b>Figure</b>		<b>Page</b>
H.1.1	Watershed Model Scenario Operations.....	15
H.1.2	Major Basins in the Chesapeake Bay Watershed .....	16
H.1.3	Conservation Tillage vs Conventional Tillage for the Chesapeake Bay Watershed.....	36
H.1.4	Conservation Tillage vs Conventional Tillage for the United States .....	37
H.2.1	Determining Fertilizer Nutrient Application Rates for Pervious Urban Areas .....	57
H.2.2	Fertilizer Application to the Phase IV Watershed Model for Pervious Urban Land .....	58
H.2.3	Cropland Mass Balance Used to Calculate the Amount of Nutrients Needed Under Nutrient Management Conditions .....	60
H.2.4	Calculating Manure Acres and their Incorporation into the Watershed Model .....	62
H.2.5	Manure Mass Balance for each Watershed Model Segment .....	63
H.2.6	Total Animal Units by County .....	66
H.2.7	Method Used to Estimate Nitrogen Applied to Pasture .....	77
H.2.8	Comparison of Modeled and Observed Manure Application Rates of TN and TP to Conventional Tillage .....	80
H.2.9	Comparison of Modeled and Observed Manure Application Rates of TN and TP to Conservation Tillage .....	81
H.2.10	Comparison of Modeled and Observed Manure Application Rates of TN and TP to Hayland .....	82

## List of Tables

<b>Table</b>	<b>Page</b>
H.1.1 BMP Identities with Associated Land Use Code.....	17
H.1.2 Correlation of Tributary Strategy BMPs with Phase IV Watershed Model BMPs .....	18
H.1.3 Conservation Reporting and Evaluation System (CRES) Practice Identities and Corresponding Watershed Model BMP Identities (used from 1985 to 1992) .....	19
H.1.4 Conservation Reporting and Evaluation System (CRES) Practice Identities and Corresponding Watershed Model BMP Identities (used from 1993 to Present) .....	20
H.1.5 An Example of Percentages of Selected Counties Within Each Corresponding Chesapeake Bay Watershed Model (WSM) Segment .....	21
H.1.6 Pennsylvania Cost-Share BMP Identities and Corresponding Chesapeake Bay Watershed Model BMP Identities (Practices tracked from 1985 to 1996) .....	22
H.1.7 Maryland Cost-Share BMP Identities and Corresponding Watershed Model BMP Identities (Practices tracked from 1985 to 1996) .....	23
H.1.8 Virginia Cost-Share BMP Identities and Corresponding Watershed Model BMP Identities (Practices tracked from 1985 to 1996) .....	24
H.1.9 Example of Maryland BMP Data Format for the Phase IV Watershed Model 1996 Progress Scenario .....	25
H.1.10 List of Maryland BMPs and Data Sources .....	27
H.1.11 Example of Pennsylvania BMP Data Format .....	29
H.1.12 Example of Virginia BMP Data .....	31
H.1.13 Example of District of Columbia's BMP Data .....	32
H.1.14 BMP Practices Resulting in a Land Use Change .....	34

<b>Table</b>	<b>Page</b>
H.2.1 Maryland’s Nutrient Reduction Efficiencies for Forest or Grass Buffers .....	42
H.2.2 Chesapeake Bay Watershed Model BMP Matrix with Associated Nutrient Reduction Efficiencies .....	43
H.2.4 Population Estimates & Projections for Chesapeake Bay Program Modeling Segments .....	50
H.2.5 Septic Loading Projections for the Chesapeake Bay Program Modeling Segments .....	53
H.2.6 Distribution of Total Nitrogen from Manure for Each Watershed Model (WSM) Segment in the Manure Mass Balance Calculation for the Phase IV Watershed Model .....	65
H.2.7 Estimated Quantities of Voided Manure from Livestock and Poultry (Normalized to 1,000 pounds of animal body weight) .....	65
H.2.8 Manure in All Confined Areas .....	68
H.2.9 Manure in Areas Susceptible to Run-off (BMPs possible) .....	70
H.2.10 Manure in Areas Always Susceptible to Run-off .....	72
H.2.11 Manure in Areas Never Susceptible to Run-off .....	74
H.2.12 Breakdown of TN Manure Applications Per 2 Days .....	78
H.2.13 Breakdown of TN Manure Applications Per Year .....	79

## Acronym Index

<b>Acronym</b>	<b>Term</b>
AU	Animal Unit
AWMSL	Animal Waste Management System (livestock)
AWMSP	Animal Waste Management System (poultry)
BF	Buffer Forested
BG	Buffer Grassed (on agricultural land)
BMP	Best Management Practice
CBP	Chesapeake Bay Program
CBPLU	Chesapeake Bay Program Land Use
CC	Cover Crop
CIMS	Chesapeake Information Management System
CRES	Federal Conservation Reporting and Evaluation System
CRP	Conservation Reserve Program
CSO	Combined Sewer Overflow
CT	Conservation Tillage
CTIC	Conservation Technology Information Center
ESC	Erosion and Sediment Control
ESWM	Enhanced Stormwater Management
FC	Forest Conservation
FCA	Forest Conservation Act (Maryland)
FHP	Forest Harvesting Practice
FSA	Farm Services Agency
GIS	Geographic Information System
HSPF	Hydrologic Simulation Program FORTRAN
MSDF	Marine Sewage Disposal Facility
NCRI	National Center for Resource Information
NMPI	Nutrient Management Plan Implementation
NRCS	National Resources Conservation Service
OSWMS	On-site Wastewater Management System
RC	Runoff Control
RHEL	Retirement of Highly Erodible Land
SC	Septic Connection
SCWQP	Soil Conservation and Water Quality Plan
SCWQPI	Soil Conservation and Water Quality Plan Implementation
SD	Septic Denitrification
SP	Septic Pumping
SPWF	Stream Protection With Fencing
SPWO	Stream Protection Without Fencing
SWCD	Soil & Water Conservation District
SWM	Stormwater Management
SWMC	Stormwater Management Conversion
SWMR	Stormwater Management Retrofit
TN	Total Nitrogen
TPLANT	Tree Planting
TP	Total Phosphorous
TSWG	Tributary Strategy Workgroup
UNM	Urban Nutrient Management
USDA	United States Department of Agriculture
USEPA	United States Environmental Protection Agency
WDM	Watershed Data Management
WSM	Watershed Model

## **Section H.1 BMP Data Management**

Nutrient reduction tracking involves: 1) accurate annual land use data, 2) annual Best Management Practice (BMP) installation or implementation data, and 3) using the land use and BMP data to simulate the effect of implemented BMPs. Annual land use and BMP data are used as input for the Phase IV Watershed Model scenarios of past, present, or projected BMP implementation conditions to calculate nutrient loads and sediment delivered to the Bay. The land use and BMP databases are necessarily large and complex due to the 64,000 square miles of land area within the Bay watershed and the wide range of BMPs applied to reduce nutrient and sediment loads. Figure H.1.1 is a schematic representation of that process. The watershed includes parts of Delaware, New York, West Virginia, Pennsylvania, Maryland, Virginia, and all of the District of Columbia (Figure H.1.2).

Since 1984, the four signatory Bay Agreement jurisdictions (Maryland, Pennsylvania, Virginia, and the District of Columbia) have expanded existing nonpoint source (nps) pollution control programs and started new programs. Cost share programs, a major component of nps control programs provide financial assistance to landowners for BMP implementation. The BMP cost share implementation data set is used as a major source of BMP tracking data within the Phase IV Watershed Model and throughout the Bay watershed.

As a result of the Chesapeake Bay Program 1992 Baywide Nutrient Reduction Strategy, the Chesapeake Reevaluation Executive Council Directive 93-1 established target load reductions for each of the ten major Chesapeake Bay Tributaries depicted in Figure H.1.2. The Directive commits each signatory jurisdiction to establish a strategy for achieving the required nutrient reductions within each tributary by the year 2000. Directive 93-1 has two implications: (1) achieving the established nutrient loading cap requires accounting for all nutrient reductions throughout the entire watershed, and (2) locations of BMP installations are needed at a sub-basin level to determine current nutrient reduction delivered to the Chesapeake Bay as estimated by the Phase IV Watershed Model.

The tracking process begins with data sets from each of the signatory state jurisdictions (Figure H.1.1, Boxes A, B, and C). In the non-signatory jurisdictions of Delaware, New York, and West Virginia, the USDA Farm Service Agency's (FSA) Federal Conservation Reporting and Evaluation System (CRES) data are used to track practices. CRES data are also used to supplement the signatory state's cost-share BMP data (i.e. BMPs implemented on private property with state or federal financial assistance). Data from the Conservation Technology Information Center (CTIC) are used to track conservation tillage.

The management, documentation, and reporting of BMP installation tracking data are the responsibility of the individual signatory jurisdictions. Each jurisdiction tracks BMP installations through cost share as well as non cost-share programs. This means that BMP installation progress reported from a signatory jurisdiction may include non-cost shared BMPs that may or may not have been installed with Soil Conservation District technical assistance. The signatory jurisdictions have agreed to use a common set of BMPs and efficiencies developed by the Tributary Strategy Workgroup as the basis for evaluating Tributary Strategy progress. Non-signatory jurisdictions use only federal CRES data in tracking BMP implementation progress.

**Figure H.1.1 Watershed Model Scenario Operations**

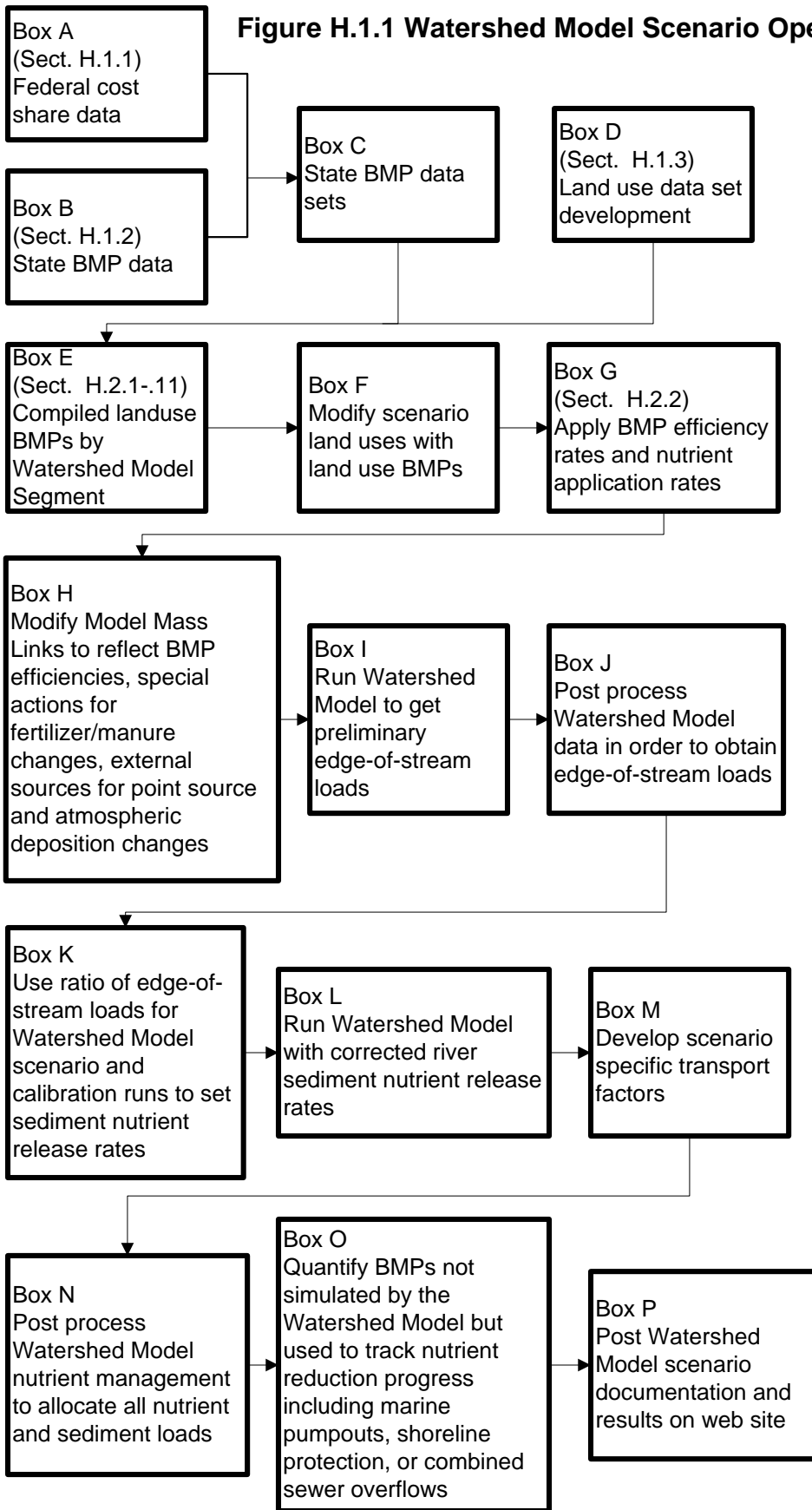

Figure H.1.2

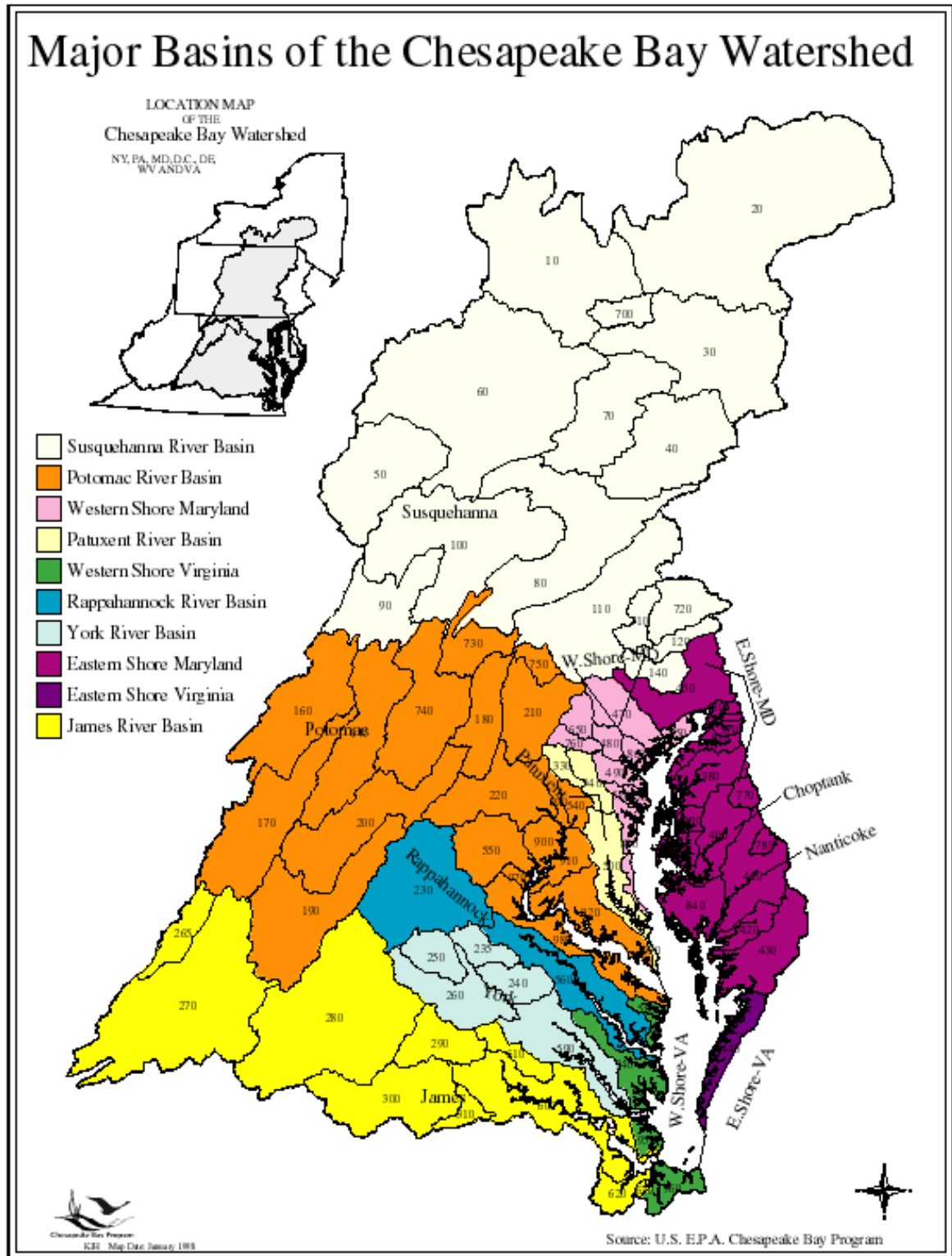



Table H.1.1 lists the Chesapeake Bay Program Watershed Model BMPs in conjunction with the applicable land use. The land use code is an accounting code which represents the land uses simulated by the Phase IV Watershed Model (WSM).

**Table H.1.1 BMP Identities With Associated Land Use Code**

WSM	Unit	Land Use Applied To	Land Use Code
BMP 1	acres	all cropland	60
BMP 2	acres	pasture	40
BMP 3	acres	conventional/conservation tilled cropland	23
BMP 4	acres	manure	70
BMP 5	acres	forest	10
BMP 6	acres	manure	70
BMP 7	acres	pasture	40
BMP 8	acres	all cropland (NM)	60
BMP 9	acres	pasture	40
BMP10	acres	forest	10
BMP11	acres	urban (pervious/impervious)	50
BMP12	acres	urban (pervious/impervious)	50
BMP13	systems	urban (pervious only)	50
BMP14	systems	urban (pervious only)	50
BMP15	systems	urban (pervious only)	50
BMP16	acres	urban (pervious only)	50
BMP17	acres	all cropland	60
BMP18	acres	all cropland	60
BMP19	acres	pasture	40
BMP20	acres	conventional tilled cropland	20

A listing of all the various BMP types and categories used in the tributary strategies has been developed by the Chesapeake Bay Program Nutrient Subcommittee's Tributary Strategy Workgroup. Table H.1.2 shows how these field BMPs relate to Chesapeake Bay Watershed Model BMPs.

**Table H.1.2 Correlation of Tributary Strategy BMPs with Phase IV Watershed Model BMPs**

<b>Category</b>	<b>Tributary Strategy BMPs</b>	<b>WSM BMPs</b>
<b>Land Use Conversions</b>		
	retirement of highly erodible land	*
	Conservation Reserve Program (CRP)	*
	forest conservation	*
	forest/grass buffers	*
	tree planting	*
	conventional tillage to conservation tillage	*
<b>Urban</b>		
Erosion and Sediment Control	erosion and sediment control	BMP11
Storm Water Management	extended detention (dry)	BMP12
	pond-wetland system (series)	BMP12
	stormwater wetland (one step)	BMP12
	retention ponds (wet)	BMP12
	SWM conversions (dry->retention)	BMP12
	sand filters	BMP12
Septic Systems	septic pumping	BMP13
	septic connections	BMP15
	septic denitrification	BMP14
Nutrient Management	nutrient management (residential)	BMP16
<b>Agriculture</b>		
Forest	forest	BMP 10
Soil Conservation WQ Plan	cropland (conventional & conservation tillage)	BMP 1
	hayland	BMP 1
	pasture	BMP 2
	animal waste management systems (dairy/beef/swine)	BMP 4
Animal Waste	animal waste management systems (poultry)	BMP 4
	supplemental (added to existing waste management system)	BMP20
Barnyard Runoff Control	full system (total barnyard control)	BMP 4
	grazing land protection (rotational grazing)	BMP 9
Grazing Land Protection	grazing land protection (rotational grazing)	BMP 9
Streambank Protection	stream protection with fencing	BMP 7
	stream protection without fencing	BMP19
	stream restoration (non-tidal)	BMP 7
Forest Harvesting	forest harvesting practices	BMP 5
Nutrient Management Plans	nutrient management plans	BMP 8
Riparian Buffers	forested	BMP18
	grassed	BMP17
Cover Crop	cover crops (cereal grain)	BMP 3
<b>Tributary Model BMPs</b>		
Marine Pumpouts	marine pumpouts (installation)	**
Shoreline Protection	structural shore erosion control	**
	nonstructural shore erosion control	**
Combined Sewer Overflows	treatment	**
	conversion of combined sewer overflow to sewer	**

\* Note 1: Land use conversions are directly simulated as a land use change and are not reduction efficiencies, therefore they are not assigned a Phase IV Watershed Model BMP number.

\*\* Note 2: Simulated as a load reduction by the Phase IV Watershed Model or the Chesapeake Bay Water Quality Model.

**Section H.1.1 Federal Cost-Share Programs**

Box A. Federal cost share data
--------------------------------------

The USDA Farm Services Agency’s Conservation Reporting and Evaluation System (CRES) tracks conservation practices implemented through the USDA federal cost-share program. This data set documents sediment and erosion control practices installed, and acres treated annually throughout the United States. A data subset may then be created which includes practices installed and acres treated for the counties within the Bay watershed. Each practice is cumulative from 1985 to the year of the Phase IV Watershed Model scenario with the exclusion of practices which regularly change on an annual basis, i.e. cover crop practices, which are not cumulative. The smallest unit of geographic reference for these BMP installations is by county. Tables H.1.3 and H.1.4 list the Conservation Reporting and Evaluation System BMP identities and corresponding Chesapeake Bay Program BMP identities used from 1985 to 1992, and from 1993 to the present, respectively.

**Table H.1.3 Conservation Reporting and Evaluation System (CRES) Practice Identities and Corresponding Watershed Model BMP Identities (used from 1985 to 1992)**

<b>CRES Practices Tracked 1985-1992</b>	<b>CRES BMP ID</b>	<b>WSM BMP ID</b>
contour farming	SL13	BMP 1
Stripcropping, contour or field	BMP3, SL3	BMP 1
terrace system	BMP4, SL4	BMP 1
diversion system	BMP5, CP6, SL5	BMP 1
waterway system	BMP7, CP8, WP3	BMP 1
sediment retention/erosion or water control structure	BMP12, CP7, WP1	BMP 1
field windbreak	CP5	BMP 1
windbreak restoration	SL7	BMP 1
grass filter strip	CP13	BMP 1
water impoundment reservoirs	WC1	BMP 1
grazing land protection system	BMP6, SL6	BMP 2
stream protection system	BMP10, WP2,	BMP 7
stream bank stabilization	SP10	BMP 7
fertilizer management	BMP15	BMP 8
cropland protection cover	SL8	BMP 3
tree planting	FP1	BMP 5
forest tree stand improvement	FR2	BMP 5

**Table H.1.4 Conservation Reporting and Evaluation System (CRES) Practice Identities and Corresponding Watershed Model BMP Identities (used from 1993 to present)**

<b>CRES Practices Tracked 1993-Present</b>	<b>CRES BMP ID</b>	<b>WSM BMP ID</b>
stripcropping systems	SL3	BMP 1
terrace systems	SL4	BMP 1
diversions	SL5	BMP 1
grazing land protection	SL6	BMP 2
field windbreak restoration or establishment	SL7	BMP 1
cropland protective cover	SL8	BMP 3
vegetative row barriers	SL12	BMP 1
sediment retention, erosion or water control structure	WP1	BMP 1
stream protection	WP2	BMP 7
sod waterways	WP3	BMP 1
agricultural waste control facilities	WP4	BMP 4
constructed wetland systems for agricultural waste	WP6	BMP 4
site preparation for natural regeneration	FR3	BMP 5
stream bank stabilization	SP10	BMP 7
forest land management roads	SP43	BMP 5
integrated crop management	SP53	BMP 8
improving a stand of forest trees	FP2	BMP 5
site preparation for natural regeneration	FP3	BMP 5
reforestation and afforestation	SIP2	BMP 5
forest improvement	SIP3	BMP 5
agroforestry establish/maintenance/renovate	SIP4	BMP 5
soil and water protection and improvement	SIP5	BMP 5
contour farming	SL13	BMP 1
water impoundment reservoirs	WC1	BMP 1
forest tree stand improvement	FR2	BMP 5
riparian buffer strips	WP7	BMP10

Since CRES data is located by state and county, and not by Phase IV Watershed Model segments, the CRES data must be redistributed by model segment before it can be used as input for the Phase IV Watershed Model. The approach assumes all practices are distributed homogeneously within each land use and each county. Each Phase IV Watershed Model segment is assigned BMP treated acres according to the proportion of the county within the Phase IV Watershed Model segment (Table H.1.5). For example, County A is divided between three Watershed Model segments: model segment 1 containing twenty percent, model segment 2 containing thirty percent, and model segment 3 containing fifty percent. An installation that treats 100 acres in County A will be represented by 20 acres treated in model segment 1, 30 acres treated in model segment 2, and 50 acres treated in model segment 3.

After all practices are assigned to the proper segment(s), they are aggregated by practice type (i.e. BMP1, BMP5, etc.) within each Phase IV Watershed Model segment. When a county falls on the boundary of the watershed only the portion of the county in the Chesapeake Bay basin is used. Examples of the percentages of various counties within the Chesapeake Bay Watershed Model segments are listed in Table H.1.5. For example, Anne Arundel County, Maryland is 100 percent in the basin and falls in six Phase IV Watershed Model segments. Kent County, Delaware is only 33 percent within the Chesapeake watershed and comprises a portion of five

Phase IV Watershed Model segments. This information, obtained by over-laying state, county, and Phase IV Watershed Model boundary information using GIS is documented in *Chesapeake Bay Watershed Model Application and Calculation of Nutrient and Sediment Loading: Appendix E, Phase IV Watershed Land Use*.

**Table H.1.5 An Example of Percentages of Selected Counties Within Each Corresponding Chesapeake Bay Watershed Model (WSM) Segment. A Complete Account of percentages of counties within Phase IV Watershed Model segments can be found in Appendix E.**

County	State	WSM Segment	Percent of County In WSM Segment
Kent	DE	380	4.99
Kent	DE	400	3.77
Kent	DE	410	10.64
Kent	DE	770	12.86
Kent	DE	780	1.79
New Castle	DE	370	2.65
New Castle	DE	380	2.57
New Castle	DE	800	2.90
New Castle	DE	810	1.50
Sussex	DE	410	38.88
Sussex	DE	420	0.21
Sussex	DE	430	4.50
Sussex	DE	780	6.40
District of Columbia	DC	220	5.24
District of Columbia	DC	540	24.63
District of Columbia	DC	890	54.06
District of Columbia	DC	910	16.08
Allegany	MD	160	60.67
Allegany	MD	170	0.01
Allegany	MD	175	39.32
Anne Arundel	MD	340	13.68
Anne Arundel	MD	490	20.95
Anne Arundel	MD	500	15.91
Anne Arundel	MD	510	11.19
Anne Arundel	MD	870	10.07
Anne Arundel	MD	880	28.18
Baltimore	MD	110	0.01
Baltimore	MD	450	1.99
Baltimore	MD	470	61.17
Baltimore	MD	480	13.31
Baltimore	MD	490	4.49
Baltimore	MD	760	8.78
Baltimore	MD	860	10.25
Calvert	MD	500	70.79
Calvert	MD	880	28.10
Calvert	MD	990	1.12

The federal BMP data (CRES) are also used for tracking BMP implementation in the three non-signatory states of New York, West Virginia, and Delaware. Linear interpolation between 1991 and 1996 CRES data are used to estimate annual BMP implementation while linear extrapolation was used to project BMP implementation to the year 2000 for the non-signatory jurisdictions. Along with cost share data from the states, CRES provides supplemental BMP tracking data for the signatory states (Maryland, Pennsylvania, and Virginia). For 1996 and beyond, CRES data are not used to augment Maryland BMP tracking data.

**Section H.1.2 State Programs (Figure H.1.1, Box B)**

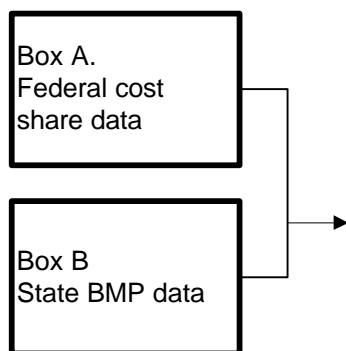

The signatory jurisdictions of Pennsylvania, Maryland, and Virginia submit data sets documenting the installation of BMP cost-shared with Chesapeake Bay Program Implementation Grants. The data sets are submitted on computer disks in various formats including ASCII, Lotus 1-2-3, QuatroPro, MS Access, and dBASE DBF. The Chesapeake Bay Program Office processes these data in order to compile a database containing information on the state, county, state BMP code, acres treated, and animal waste stored. Tables H.1.6-8 list the BMPs used in the Pennsylvania, Maryland, and Virginia cost-share programs, respectively, and their corresponding Chesapeake Bay Watershed Model BMP identity.

**Table H.1.6 Pennsylvania Cost-Share BMP Identities and Corresponding Chesapeake Bay Watershed Model BMP Identities (Practices tracked from 1985 to 1996)**

<b>BMP NAME</b>	<b>PA BMP ID</b>	<b>WSM BMP ID</b>
stripcropping, contour or field	3	BMP 1
terrace system	4	BMP 1
diversion system	5	BMP 1
waterway system	7	BMP 1
sediment retention/erosion or water control	12	BMP 1
grazing land protection system	6	BMP 2
stream protection system	10	BMP 2
cropland system (cover crop)	8	BMP 3
animal waste management	2	BMP 8
nutrient management	16	BMP 4

**Table H.1.7 Maryland Cost-Share BMP Identities and Corresponding Watershed Model BMP Identities (Practices tracked from 1985 to 1996)**

<b>BMP NAME</b>	<b>MD BMP ID</b>	<b>WSM BMP ID</b>
contour farming	330	BMP 1
stripcropping, contour or field	585	BMP 1
stripcropping, contour or field	586	BMP 1
terrace system	600	BMP 1
diversion system	362	BMP 1
waterway system	412	BMP 1
waterway system	468	BMP 1
contour orchard/fruit area	331	BMP 1
sediment basin	350	BMP 1
field border	386	BMP 1
field windbreak	392	BMP 1
grass filter strip	393	BMP 1
spring development	574	BMP 2
trough or tank	614	BMP 2
fencing	382	BMP 2
cover and green manure crop	340	BMP 3
animal waste control facility	313	BMP 4
animal waste control facility	359	BMP 4
animal waste control facility	425	BMP 4
forest land erosion control system	408	BMP 5
forest land management	409	BMP 5
roof runoff management	558	BMP 4
grade stabilization structure	410	BMP 1

**Table H.1.8 Virginia Cost-Share BMP Identities and Corresponding Watershed Model BMP Identities (Practices tracked from 1985 to 1996)**

<b>BMP NAME</b>	<b>VA BMP ID</b>	<b>WSM BMP ID</b>
stripcropping, contour or field	SL-3	BMP 1
buffer stripcropping	SL3-B	BMP 1
terrace system	SL-4	BMP 1
diversion system	SL-5	BMP 1
waterway system	WP-3	BMP 1
sediment retention/erosion or water control	WP-1	BMP 1
grass filter strip	WQ-1	BMP 1
grass filter strip (restrictive)	WQ-2	BMP 1
water table control structure	WQ-5	BMP 1
grazing land protection system	SL-6	BMP 2
stream protection system	WP-2	BMP 7
intensive rotational grazing	WQ-3	BMP 9
protective cover for specialty crops	SL-8	BMP 3
specialty cover crop for nutrient management	SL-8B	BMP 3
legume cover crop	WQ-4	BMP 3
animal waste control facility	WP-4	BMP 4

Information from state databases are submitted on a county basis, not by Chesapeake Bay Watershed Model segment. The same process used with the CRES data to distribute BMP implementation data to Watershed Model segments is applied to these cost share databases. Each practice is cumulative from 1985 except for practices which change regularly on an annual basis such as conservation tillage.

Development of tributary strategies by the signatory jurisdictions brought changes in how BMP data are submitted to the Chesapeake Bay Program Office. Watershed Model data sets represent the cumulative implementation of BMPs since 1985, from all sources, including, but not limited to state cost-share and federal cost-share programs as well as from other programs, such as the USDA Natural Resources Conservation Service and Conservation Districts programs. These data are developed by the signatory jurisdictions. Practices tracked for these signatory jurisdictions correspond to those listed in their tributary strategies. Tables H.1.9-1.12 are examples of the data submitted by individual state jurisdictions to the Chesapeake Bay Program Office. These databases can be accessed on the Chesapeake Bay Program Modeling Subcommittee Web Page at:

<http://www.chesapeakebay.net/bayprogram/pol/mdsc/model.htm>



**Table H.1.9 Example of Maryland BMP Data Format for the Phase IV Watershed Model 1996 Progress Scenario**

<b>WSM Segment</b>	<b>BMP Code</b>	<b>PROGRESS 1996</b>	<b>UNIT</b>	<b>BMP Description</b>
110	AWMSL	1.20	systems	animal waste management systems livestock
110	AWMSP	0.00	systems	animal waste management systems poultry
110	BF	0.79	acres	buffers forested
110	BG	0.98	acres	buffers grassed (agricultural land)
110	CC	15.47	acres	cover crops
110	CT	1182.36	acres	conservation tillage
110	ESC	0.65	acres	erosion and sediment control
110	ESM	1.39	acres	enhanced stormwater management
110	FC	0.00	acres	forest conservation
110	FHP	0.00	acres	forest harvesting practices
110	NMPI	674.13	acres	nutrient management plan implementation
110	RC	0.17	systems	runoff control
110	RHEL	0.33	acres	retirement of highly erodible land
110	SC	0.40	systems	septic connections
110	SCWQP	930.47	acres	SCWQP treatment of highly erodible land
110	SD	0.00	systems	septic denitrification
110	SMC	0.02	acres	stormwater management conversion
110	SMR	0.01	acres	stormwater management retrofits
110	SP	0.00	systems	septic pumping
110	SPWF	0.75	acres	stream protection with fencing
110	SPWOF	0.69	acres	stream protection without fencing
110	TP	0.20	acres	tree planting
110	UNM	0.00	acres	urban nutrient management
140	AWMSL	17.22	systems	animal waste management systems livestock
140	AWMSP	0.00	systems	animal waste management systems poultry
140	BF	15.49	acres	buffers forested
140	BG	0.00	acres	buffers grassed (agricultural land)
140	CC	60.32	acres	cover crops
140	CT	7000.33	acres	conservation tillage
140	ESC	13.93	acres	erosion and sediment control
140	ESM	27.45	acres	enhanced stormwater management
140	FC	0.56	acres	forest conservation
140	FHP	0.00	acres	forest harvesting practices
140	NMPI	6188.91	acres	nutrient management plan implementation
140	RC	16.85	systems	runoff control
140	RHEL	3.38	acres	retirement of highly erodible land
140	SC	2.09	systems	septic connections
140	SCWQP	8738.55	acres	SCWQP treatment of highly erodible land
140	SD	0.00	systems	septic denitrification
140	SMC	1.92	acres	stormwater management conversion
140	SMR	3.50	acres	stormwater management retrofits
140	SP	0.00	systems	septic pumping
140	SPWF	431.40	acres	stream protection with fencing

Maryland submits Chesapeake Bay BMP tracking data in spreadsheet format using Quattro Pro (Table H.1.10). Maryland tracks BMP implementation through several different databases, including the Maryland Agriculture Water Quality cost-share program database, the Maryland Department of Natural Resources (MD DNR) Forest Service Target and Accomplishment Reporting System, the Federal Conservation Technology Information Center, the Maryland Department of Environment (MDE) Water Management Administration (WMA) Notice of Intent (NOI) database, the MDE Environment Technical And Regulatory Services Administration (TARSA) Urban BMP database, the MD DNR Forest Service, the Nutrient Management Program of Maryland Department of Agriculture Office of Resource Conservation, the MDE Nonpoint Source database, the Soil Conservation Districts reports to the USDA-Natural Resources Conservation Service (USDA-NRCS) and the Maryland Department of Agriculture (MDA). Table H.1.10 lists Maryland's BMPs used within the Phase IV Watershed Model and the sources of these BMP data. In addition to these databases, the MD DNR Waterway Resources Division marina database is used to track shoreline erosion BMPs throughout the state. MD DNR Shore Erosion Control staff developed this database to account for the number of marine pumpouts installed, and structural and nonstructural shore erosion control installations throughout Maryland. Additional documentation on the data sources for Maryland's BMPs may be found in the tributary strategy team's annual reports.

**Table H.1.10 List of Maryland BMPs and Data Sources**

<b>Maryland's BMP Code</b>	<b>Option</b>	<b>Maryland's Sources of BMP Data</b>
ESC	Erosion and Sediment Control	MDE WMA Notice of Intent database
ESM	Enhanced Stormwater Management	MDE TARSA Urban BMP database
SMR	Stormwater Management Retrofits	MDE Nonpoint Source database
SMC	Stormwater Management Conversion	MDE Nonpoint Source database
SP	Septic Pumping	Data currently not yet available
SD	Septic Denitrification	MDE Nonpoint Source database
SC	Septic Connections	MDE Nonpoint Source database
UNM	Urban Nutrient Management	Data currently not available
SCWQP	SCWQP Implementation	Soil Conservation Districts reporting to USDA, NRCS and MDA
AWMSL	Animal Waste Management Systems livestock	MD Agricultural Water Quality Cost-share program database
AWMSP	Animal Waste Management Systems poultry	MD Agricultural Water Quality Cost-share program database
RC	Runoff Control	MD Agricultural Water Quality Cost-share program database
RHEL	Retirement of Highly Erodible Land	MD Agricultural Water Quality Cost-share program database
SPWF	Stream Protection with Fencing	MD Agricultural Water Quality Cost-share program database
SPWOF	Stream Protection without Fencing	MD Agricultural Water Quality Cost-share program database
NMPI	Nutrient Management Plan Implementation	Nutrient Management Program of MDA Office of Resource Conservation
CC	Cover Crops	MD Agricultural Water Quality Cost-share program database
BF	Buffers Forested	MD DNR Forest Service Target and Accomplishment Reporting System
BG	Buffers Grassed (agricultural land)	MD Agricultural Water Quality Cost-share program database
FHP	Forest Harvesting Practices	Data currently not available
FC	Forest Conservation	MD DNR Forest Service
TP	Tree Planting	MD DNR Forest Service Target and Accomplishment Reporting System
CT	Conservation Tillage	Federal Conservation Technology Information Center

Pennsylvania submits Watershed Model BMP tracking data in a Microsoft Excel spreadsheet format (Table H.1.11). For example, Pennsylvania's Watershed Model 1996 Progress Scenario BMP data were compiled from data received from the USDA Farm Service Agency (FSA), the USDA-NRCS, the Pennsylvania Game Commission, and the Pennsylvania Department of Environmental Protection (PADEP) cost-share program. BMP data from these agencies are first compiled on a county basis. Due to the differences in reporting methods used by the various agencies, the possibility exists that permanent vegetative cover, strip cropping systems, cropland protection systems, and conservation tillage practices reported by the federal and state cost-share programs may be double-counted. To avoid this problem, the acres reported under Pennsylvania's cost-share program are subtracted from the acreage reported by the federal programs. The county data were then redistributed among the Phase IV Watershed Model segments using a method similar to that previously described for the federal cost-share program.

Table H.1.11 displays Pennsylvania's BMP data per Watershed Model segment and land use. The conservation tillage column values are given in units of acres converted from conventional tillage to conservation tillage. The nutrient management column values are provided in units of cropland acres converted to nutrient management practices. These nutrient management practices include manure storage/handling and fertilizer applications at rates that agree with the agronomic needs of the land. The farm plan column provides values in acres of cropland under farm plans and covers a wide range of BMP practices. Farm plan BMP practices can be generally described as pasture and cropland management practices. The stream bank fencing column provides acreage values where stream bank fencing is implemented.

**Table H.1.11 Example of Pennsylvania BMP Data Format**

<b>WSM Segment</b>	<b>Land Use</b>	<b>Conservation Tillage<sup>1</sup></b>	<b>Nutrient Management (acres)</b>	<b>Farm Plan (acres)</b>	<b>Stream Bank Fencing (acres)</b>
10	conventional tillage	16137.00	5077.00	15129.67	
10	conservation tillage			2255.33	
10	hayland				
10	pasture			2913.00	26.00
10	animal waste		23.00		
10	forest				
10	urban				
20	conventional tillage	4648.00	3549.00	3653.86	
20	conservation tillage			261.14	
20	hayland				
20	pasture			279.00	20.00
20	animal waste		28.00		
20	forest				
20	urban				
30	conventional tillage	50714.60	17376.00	40449.20	
30	conservation tillage			14568.80	
30	hayland				
30	pasture			9600.00	128.00
30	animal waste		155.00		
30	forest				
30	urban				

<sup>1</sup> given in units of acres converted from conventional tillage to conservation tillage

Virginia submits Chesapeake Bay Watershed Model Progress Scenario BMP tracking data in comma delimited text file format (Table H.1.12). Virginia's BMP data are submitted to the Chesapeake Bay Program Office on a Watershed Model segment basis. Several sources are used in Virginia to obtain BMP data but the majority of the data are obtained through the Virginia Agricultural cost-share program BMP database. This Virginia cost-share program is administered through local Soil and Water Conservation Districts. As part of the cost-share program, each Soil and Water Conservation District is required to make quarterly reports of BMP implementation to the Virginia Department of Conservation and Recreation in a database format. This database includes the latitude and longitude of each BMP implemented and is easily translated into Watershed Model segments. The cost-share program database is supplemented with data from an extensive Virginia farm operator survey of BMP implementation without state or federal cost-share assistance. Conservation tillage information is derived from CTIC data. Nutrient management data are provided from a Virginia Department of Conservation and Recreation database, which includes information on all nutrient management plans written or approved by state nutrient management specialists. During Virginia's Tributary Strategy development process, agricultural specialists at the local level verified all of these data.

Urban BMP implementation data were also collected from participating localities during the tributary strategy development process. These data include erosion and suspended sediment control, storm water management retrofits, urban nutrient management, and septic pumping. Data are typically collected on a county basis and are aggregated to Watershed Model segments on a proportional basis. Shoreline erosion protection data are taken from a study on highly erodible shoreline and BMP implementation in the Virginia portion of the Chesapeake Bay. The source of the forest harvesting data is the Virginia Department of Forestry.

**Table H.1.12 Example of Virginia BMP Data**

<b>BMP Treatment</b>	<b>Units</b>	<b>Model Segment 170</b>	<b>Model Segment 200</b>	<b>Model Segment 220</b>	<b>Sum of Potomac Basin Model Segments</b>
conservation tillage	acres	270	20,854	23,855	156,533
farm plans	acres	1,386	69,551	68,497	392,139
nutrient management	acres	1,322	73,469	17,712	276,471
highly erodible land retirement	acres	535	3,126	2,716	23,133
grazing land protection	acres	1,200	16,400	4,242	36,609
stream protection	acres	0	708	925	3,298
stream fencing	linear feet	0	9,959	206	167,328
stream protection	linear feet	0	469	0	14,012
cover crops	acres	43	5,581	161	19,643
grass filter strips	acres	313	2,981	858	11,483
woodland buffer filter area	acres	4	298	97	900
forest harvesting	acres	233	2,215	591	8,378
animal waste control facilities	systems	0	72	3	212
poultry waste control facilities	systems	2	232	1,152	4,907
loafing lot management	systems	0	5	446	1,851
erosion and sediment control	acres	3	272	1,402	6,199
urban SWM/BMP retrofits	acres	0	0	489	1,965
urban nutrient management	acres	2	161	791	16,398
septic pumping	systems	0	0	15	72
shoreline erosion protection	linear feet	0	0	0	9,575

The District of Columbia reports BMP implementation in both a text file and hard copy printout (Table H.1.13). Data submitted by the District of Columbia is taken from DC's BMP implementation programs. Stormwater management implementation databases are ground-truthed within the District and these databases include information on the type, location, status, and drainage area of stormwater management facilities. Site inspections are conducted by the Soil Resources Management Division (Department of Consumer and Regulatory Affairs) to verify the presence of each BMP, thereby obtaining an accurate accounting of all urban BMPs implemented within a given year.

**Table H.1.13 Example of District of Columbia's BMP Data**

<b>BMP</b>	<b>Number of BMPs</b>	<b>Acres Treated Treated</b>	<b>Year</b>
dry pond (extended)	1	10.00	1988
dry pond (extended)	2	17.40	1991
dry pond (extended)	2	27.60	1992
wet ponds	1	0.69	1991
infiltration trenches	1	0.16	1988
infiltration trenches	2	0.86	1989
infiltration trenches	1	0.34	1990
infiltration trenches	3	1.67	1991
infiltration trenches	2	2.11	1992
infiltration trenches	2	0.67	1993
infiltration trenches	1	0.25	1994
oil/grit	17	18.54	1988
oil/grit	3	4.15	1989
oil/grit	4	3.51	1990
oil/grit	10	11.27	1991
oil/grit	3	2.30	1992
oil/grit	2	1.10	1993
sand filters	2	2.40	1988
sand filters	24	21.42	1989
sand filters	24	25.87	1990
sand filters	22	26.65	1991
sand filters	9	7.46	1992
sand filters	14	12.46	1993
sand filters	18	19.19	1994
sand filters	8	12.85	1995
underground detention (i.e. oversized pipes)	3	1.45	1988
underground detention (i.e. oversized pipes)	2	12.00	1990
underground detention (i.e. oversized pipes)	3	9.75	1991
underground detention (i.e. oversized pipes)	1	0.74	1992
underground detention (i.e. oversized pipes)	1	2.51	1993
water quality inlets	2	2.53	1988
water quality inlets	1	9.40	1990



Data from all jurisdictions are converted to MS Excel format before being imported into an MS ACCESS 2.0 database. This BMP database is part of the Chesapeake Bay Information Management System (CIMS). For Watershed Model segments that contain portions of more than one state, the data are aggregated into one model segment by adding the acres associated with each model BMP in each model segment. When all the BMP tracking data has been processed, it is then applied in the Phase IV Watershed Model (Figure H.1.1, Box C).

### Section H.1.3 Land Use Conversions (Figure H.1.1, Box D)

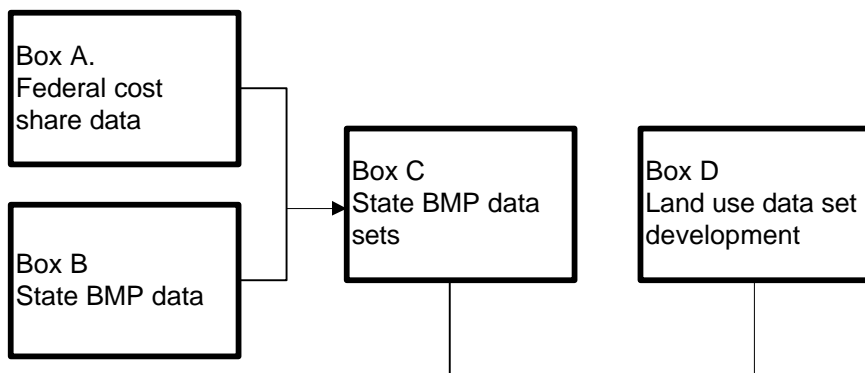

Some BMPs involve a change in land use, for example - highly erodible land (HEL) in cropland is retired and converted to pasture. Land use conversions are a significant portion of BMP nutrient reductions in the Chesapeake Bay Watershed and are simulated directly in the Phase IV Watershed Model as a change in land use area. Data for land use conversions of conventional tillage to conservation tillage are developed through county level CTIC data for each simulation year. Other land use conversions such as forest buffers and urban forestry are tracked in the state BMP data bases.

For those land use conversions tracked throughout the watershed, including signatory and nonsignatory states, the primary data sets consist of information from Conservation Technology Information Center. Other data include land use change BMPs tracked through state implementation grants and USDA Farm Services Agency's BMP installations. Table H.1.14 lists those categories that create land use changes.

**Table H.1.14 BMP Practices resulting in a Land Use Change**

<b>BMP Type</b>	<b>Land Use Change</b>
Conservation Reserve Program (CRP)	cropland to pasture
forest conservation	pervious urban to forest
forest/grass buffers	cropland to forest/pasture
tree planting	cropland/pasture to forest
conventional tillage/conservation tillage	conventional tillage to conservation tillage

### **Land use Conversions from Conventional Tillage to Conservation Tillage**

In the Phase IV Watershed Model, conservation tillage is tracked on an annual basis to reflect increases or decreases that occur in tillage management. Acreage in conservation tillage for each of the six Chesapeake Bay basin states was obtained through the Conservation Technology Information Center (CTIC). CTIC provides annual data sets for each state showing the acres of cropland planted using conservation tillage.

CTIC collects these data in an annual survey conducted on a county-by-county basis by USDA Natural Resources Conservation Service offices, and soil and water conservation districts to track tillage systems used on annually planted crops. The acreage for “Total Cropland Planted” and “Total Cropland Planted Using Conservation Tillage” major data categories is tracked by the CTIC surveys and used by the Chesapeake Bay Program. Within this CTIC data set, conservation tillage is further broken down into the following major data subcategories; “15-30 Percent Residue Tillage,” “Under 15 Percent Residue Tillage,” “Mulch Tillage,” and “No-Till Tillage.” Tillage methods and acreage for the following crop types are estimated by the annual surveys: corn full season and double cropped; small grain fall and spring seeded; soybeans full season and double cropped; cotton; grain sorghum full season and double cropped; forage crops; and other crops.

Once the Chesapeake Bay Program obtains these data, a CTIC software program (CEDAR) is used to organize the data into a new data set that includes “Total Tillage” (all acres planted, including those planted by conservation tillage) and “Conservation Tillage” (all acres planted using conservation tillage) for each county. This data set includes the following crops: corn full season; small grain fall and spring seeded; soybeans full season; cotton; grain sorghum full season; forage crops; and other crops. To eliminate double counting of acres, the double cropped acres are not included in this data set. Forage is included, since at the planting stage it responds more like tilled cropland in the first season of growth.

This data set is normalized to the cropland areas represented in the Phase IV Watershed Model by adding all acres of the above crops for both “Total Tillage” and “Conservation Tillage,” and then dividing “Conservation Tillage” by “Total Tillage” to get “Percent Conservation Tillage” for each county. This percent value is then used to adjust conservation and conventional tillage within each county of the Chesapeake Bay Program Land Use data set. This adjustment is made within the data set by multiplying the “Percent Conservation Tillage” by the total cropland (less

hayland) for each county to get the acres of conservation tillage in each county. The difference between total cropland (less hayland) and conservation tillage is the conventional tillage acres. Both conservation and conventional tillage acres are multiplied by the percent of county in each Phase IV Watershed Model segment. These county values are added to obtain both conservation and conventional tilled acres within each model segment.

Figure H.1.3 shows the amount of conservation tillage compared to the amount of conventional tillage as modeled by the Phase IV Watershed Model. The Chesapeake Bay Watershed, in 1985 had more conservation tillage than conventional. By the year 2000, it is projected that conservation tillage will have been implemented on even more acres. The trend of decreasing conventional tillage and increasing conservation tillage practice is also evident in Figure H.1.4 on a national basis.

**Figure H.1.3 Conservation Tillage vs. Conventional Tillage for the Chesapeake Bay Watershed**

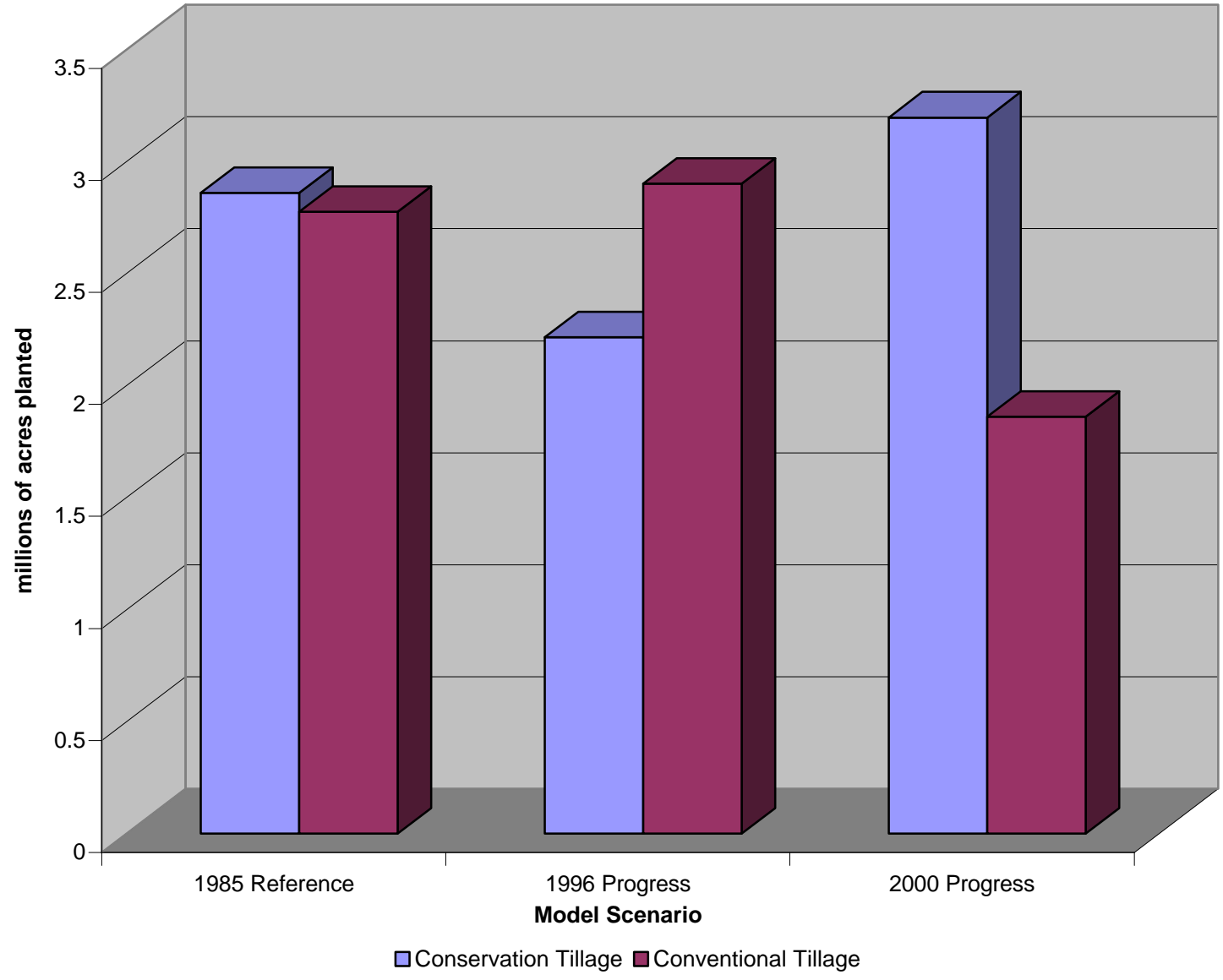

**Figure H.1.4 Conservation Tillage vs. Conventional Tillage for the United States**  
(<http://ctic.purdue.edu/survey>)

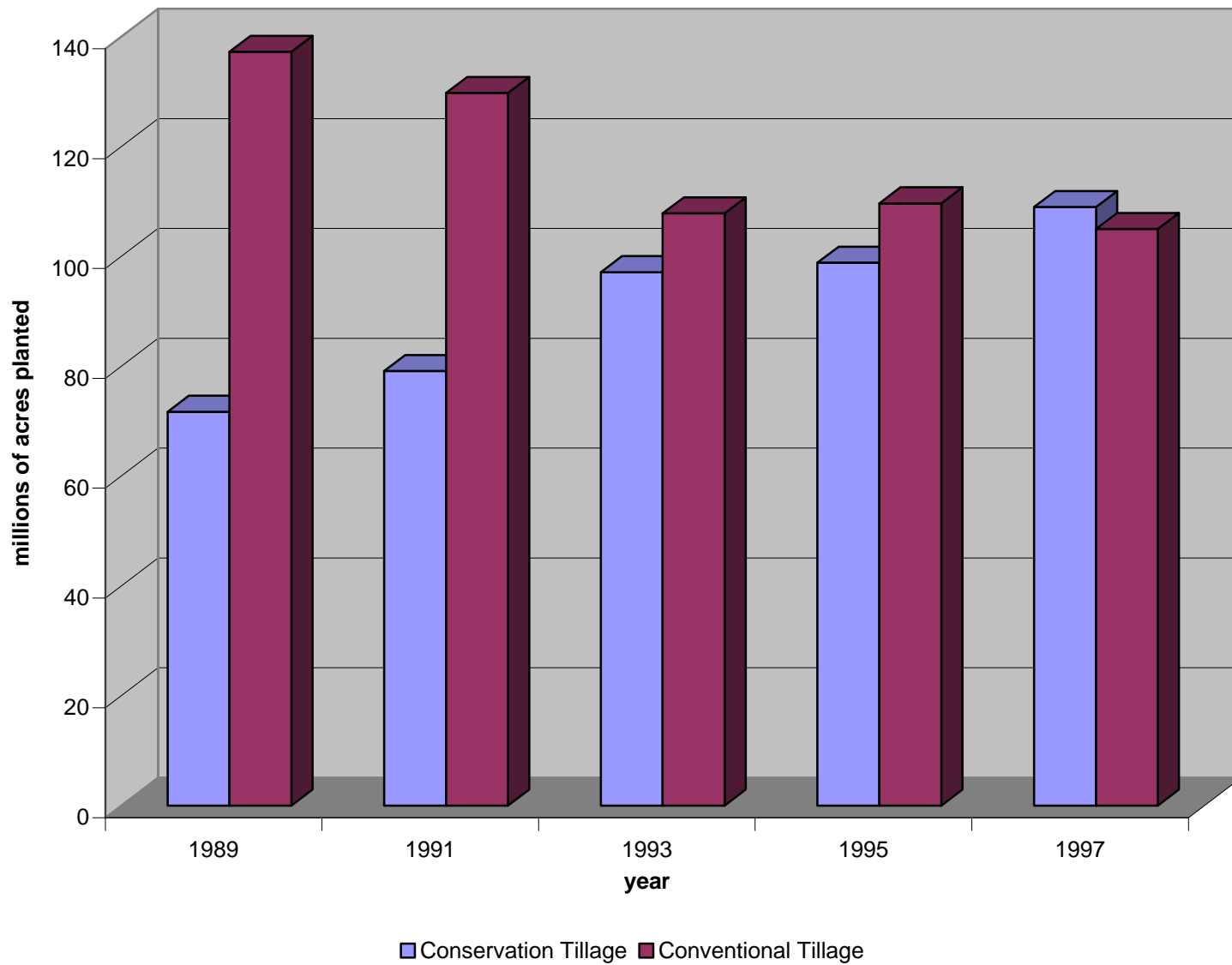

## Section H.2 IMPLEMENTATION OF NUTRIENT MANAGEMENT BMP APPLICATION RATES AND BMP NUTRIENT REDUCTION EFFICIENCY RATES

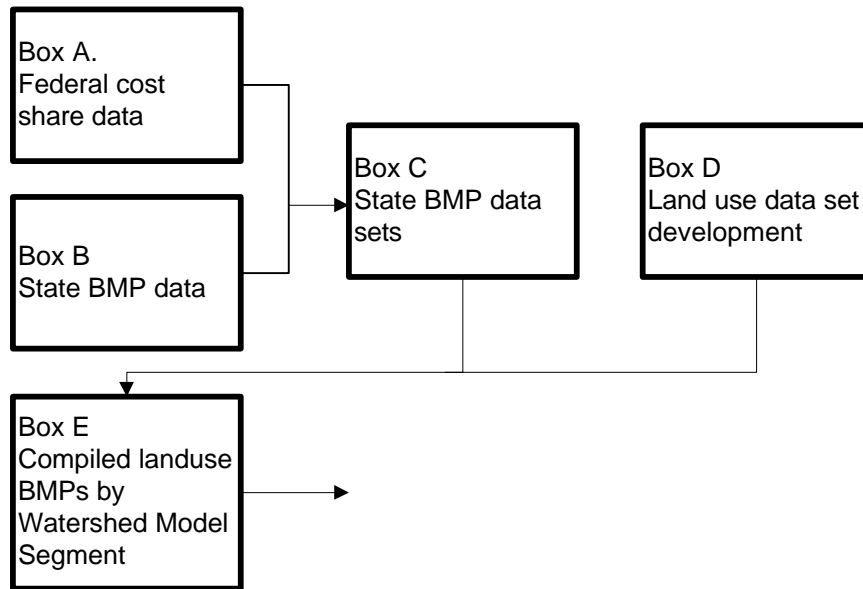

The Phase IV Watershed Model simulates BMP nutrient reductions by land use conversions (i.e. conventional tillage to conservation tillage), application of BMP nutrient reduction efficiencies, and nutrient management. The following sections describe how the effects of BMPs are simulated within the Phase IV Watershed Model, lists BMPs identified by current tributary strategies, and includes the range of nutrient reduction efficiency values used within the Phase IV Watershed Model.

### Section H.2.1 BMPs Involving Land Use Conversion (Figure H.1.1, Box E)

Land use conversions within all Chesapeake Bay basin jurisdictions are accounted for through the use of the Phase IV Watershed Model through a land use acreage change from one land use to another. Because the Phase IV Watershed Model simulates only a total acreage value for each model segment, any land use changes must be averaged over the total land use acreage and then applied to the total acreage value within a model segment.

Land use conversions simulated by the Chesapeake Bay Watershed Model are forest/grass buffers, conservation reserve program, forest conservation, tree planting, and changing conventional tillage to conservation tillage. These land use conversions occur on the land through the conversion of cropland to conservation reserve program acres, urban land to forest (through forest conservation), urban land to forest (through tree planting programs), conventional tillage to conservation tillage, and urban or cropland to forest/grass buffers. A final land use conversion (used only by Maryland) is highly erodible land to pasture. Implemented land use conversions cause nutrient load reductions because they change the edge-of-stream loading rate into a lower rate thereby reducing nutrient and suspended sediment loads delivered to the Bay.

### **Section H.2.1.1 Conservation Reserve Program**

Authorized by the Amended Food Security Act of 1985, the Conservation Reserve Program (CRP) is a voluntary program that offers annual land rental and incentive payments to farmers establishing conservation practices and planting permanent vegetative cover for 10-15 years. The program encourages farmers to convert highly erodible cropland to grass and trees. In 1997, revisions were made to the Conservation Reserve Program stating that only croplands that are used to grow commodities, or marginal pastures that are either enrolled in the Water Bank Program or suitable for use as forested riparian buffers are eligible for the program. In addition, croplands must either be: highly erodible; considered cropped wetland; devoted to highly beneficial environmental practices (i.e. riparian buffers, filter strips, etc.); subject to scour erosion; or be in a national or state Conservation Reserve Program priority area.

In most cases, it is not possible to determine if land is converted to grass or trees, so it is assumed that all acres are planted to grass. In Virginia, critical areas may be converted to forest through a state program. In this case, the areas of converted cropland to forest are known, which allows this conversion to forest to be applied in the Phase IV Watershed Model.

### **Section H.2.1.2 Forest Conservation**

Forest conservation land use conversion is based upon estimates in the amount of forest land saved between 1993 and 2000 as a result of Maryland's Forest Conservation Act. Incorporation of forest conservation practices consist of a land use conversion from developed land (pervious urban) to forest. Maryland's Forest Conservation Act helps to maintain and enhance forest cover by requiring the identification of priority areas for forest retention, setting guidelines for development that require the retention of 15-50 percent of the forested area, and replanting of cleared areas. Priority areas are designated as 100-year flood plains, intermittent and perennial streams and their buffers, steep slopes, and critical habitats. This BMP reduces deforestation created by urban development by requiring that a certain percentage of developed land remain as forested land.

The substitution of forest land for what would otherwise be urban land is best understood within the context of how the Phase IV Watershed Model projects land use. For any year other than 1990, the year of the Chesapeake Bay Program land use data base, land use is projected forward or backward based on population. As population increases within a model segment, urban land use area increases proportional to the 1990 urban land use and population, and the land uses of forest and agriculture, proportionally decrease. Forest Conservation Act BMPs reduce this constant rate of urbanization as projected through population growth.

### **Section H.2.1.3 Tree Planting**

The tree planting BMP includes any tree plantings on any site except those along rivers and streams. Plantings along rivers and streams are considered riparian buffers and are treated differently. The definition of tree planting does not include reforestation. Reforestation replaces trees removed during timber harvest and does not result in an additional nutrient reduction or an increase in the forest acreage.

#### **Section H.2.1.4 Conservation Tillage**

Conservation tillage involves planting and growing crops with minimal disturbance of the surface soil using a non-inversion plowing technique and maintaining a 30 percent minimum crop residue cover on the soil surface. No-till farming is a form of conservation tillage in which the crop is seeded directly into slits cut into the soil, therefore, no tillage of the soil surface is needed. Minimum tillage farming involves some disturbance of the soil surface, but maintains a minimum of 30 percent crop residue on the surface. Research has shown that with at least 30 percent of the crop residue remaining at the time of planting, the amount of erosion and resultant nutrient loss are substantially reduced.

Conservation tillage is a land use simulated by the Phase IV Watershed Model. Conservation tillage involves a simple land use change in the land acreage cover between conventional and conservation tillage. Each Watershed Model segment acre in conservation tillage is determined annually using Conservation Technology Information Center county level data.



### **Section H.2.1.5 Forest and Grass Buffers**

Buffers, which are linear strips of vegetation along rivers and streams, help to filter nutrients, sediment, and other pollutants carried in runoff, as well as excess nutrients in groundwater. If signatory States report buffer BMPs implemented in linear feet, buffers are assumed to be 100 feet wide on a streamside. Based on this buffer width, nutrient reductions in the Phase IV Watershed Model are assumed to be two acres of upgradient land treated for each buffer acre. If signatory States report buffer BMPs implemented as acres treated, then the buffer nutrient reduction efficiency is directly applied to the reported land use.

Forest and grass buffers are incorporated into the Phase IV Watershed Model simulation in two ways. Forest/grass buffers include both a land use conversion on the riparian area and a land use load reduction from upgradient land. Forest buffer land use conversion is a change in land use from cropland to forest. Grass buffer land use conversion is a change from cropland to pastureland.

Buffers also reduce nutrient loads from land adjacent to, and upgradient from, the buffer. Although soil types, vegetative type, width of buffer, and other factors alter the buffer's effectiveness, it is assumed that an acre of forest or grass buffer reduces loads from 2 acres of land adjacent to, and upgradient from the buffer.

The tracking of buffer BMPs is calculated according to buffer area. The Chesapeake Bay Program Office assume one buffer acre for every 435.6 linear feet of riparian buffer (assumed to be 100 feet wide). Land adjacent to the buffer are assumed to be cropland in Virginia, Maryland, and Pennsylvania, and urban land in the District of Columbia, unless otherwise specified. In Pennsylvania, Virginia, and the District of Columbia, forested buffers are estimated to reduce the nitrogen load by 57 percent and both the phosphorus and suspended sediment loads by 70 percent on upgradient agricultural, and urban land uses. Grass buffers are estimated to reduce the upgradient nitrogen load by 43 percent, and the phosphorus and suspended sediment loads by 53 percent.

It is assumed that a certain percentage of stream miles within urban pervious and urban impervious land uses are impractical for buffer implementation. These assumptions are included in the Phase IV Watershed Model by removing 100 percent of the urban impervious and 50 percent of the urban pervious stream miles from buffer eligibility.

In Maryland the efficiencies of forest or grass buffers are estimated for each tributary basin as described in Table H.2.1.

**TABLE H.2.1 Maryland's Nutrient Reduction Efficiencies for Forest or Grass Buffers**

<b>Basin</b>	<b>Buffer Type</b>	<b>% TN Efficiency</b>	<b>% TP Efficiency</b>
<b>Upper Potomac</b> (Model Segments 160, 175, 180, 210, 730, 740, 750)	forest	48	36
	grass	36	53
<b>Middle Potomac</b> (Model Segments 220, 540, 890)	forest	51	70
	grass	38	53
<b>Lower Potomac</b> (Model Segments 910, 920, 990)	forest	56	70
	grass	42	53
<b>Patuxent</b> (Model Segments 330, 340, 500)	forest	56	70
	grass	42	53
<b>Patapsco/Back</b> (Model Segments 480, 490, 660, 760, 860)	forest	56	70
	grass	41	53
<b>Upper Western</b> (Model Segments 510, 870, 880)	forest	49	70
	grass	37	53
<b>Lower Western</b> (Model Segments 470, 850)	forest	56	70
	grass	42	53
<b>Upper Eastern</b> (Model Segments 370, 380, 390, 450, 800, 810, 820, 830)	forest	58	70
	grass	43	53
<b>Lower Eastern</b> (Model Segments 410, 420, 430, 780, 840)	forest	66	70
	grass	49	53
<b>Choptank</b> (Model Segments 400, 770)	forest	59	70
	grass	44	53

**Section H.2.2 BMPs Involving Nutrient Reduction Efficiencies (Figure H.1.1, Box G)**

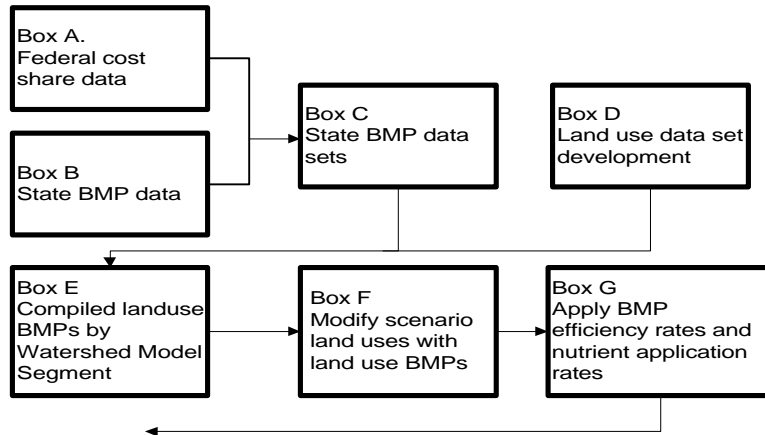

Within the Phase IV Watershed Model, BMP nutrient reduction efficiencies are applied to nitrogen, phosphorus, and suspended sediment nutrient loads (Figure H.1.1, Box G, page 2). Nutrient reduction efficiencies associated with the implementation of BMPs throughout the Chesapeake Bay signatory states are listed in Table H.2.2.

**Table H.2.2 Chesapeake Bay Watershed Model BMP Matrix With Associated Nutrient Reduction Efficiencies**

Category (Units)	Type of Watershed Model BMP	Reduction Efficiency	Reduction Efficiency	Reduction Efficiency
		N (%)	P (%)	TSS (%)
urban <sup>1</sup>	erosion and sediment control (BMP 11)	33	50	50
urban – stormwater management <sup>2</sup>	extended detention (dry) (BMP 12)	25	20	20
	retention ponds (wet) (BMP 12)	32	46	46
	stormwater wetland (one step) (BMP 12)	25	47	47
	pond-wetland system (series) (BMP 12)	29	64	64
	SWM conversions (dry->retention) (BMP 12)	32	46	46
	sand filters (BMP 12)	30	45	80

<sup>1</sup> acres treated

<sup>2</sup> acres protected

Category	Type of Watershed Model BMP	Reduction Efficiency N (%)	Reduction Efficiency P (%)	Reduction Efficiency TSS (%)
urban – septic systems <sup>3</sup>	septic pumping (BMP 13)	5	0	0
	septic connections (BMP 15)	55	0	0
urban – septic systems <sup>3</sup>	septic denitrification (BMP 14)	50	0	0
urban <sup>1</sup>	nutrient management (residential) (BMP 16)	17	22	0
agriculture SCWQ <sup>4</sup> plan implementation	cropland (conventional/conservation tillage) (BMP 1)	10/4	40/8	40/8
	hayland (BMP 1)	4	8	8
	pasture (BMP 2)	20	14	14
agriculture <sup>5</sup>	animal waste management systems (AWMS) (dairy/beef/swine) (BMP 4)	80	80	-
	AWMS (poultry) (BMP 4)	14	14	-
agricultural barnyard runoff control <sup>3</sup>	supplemental (added to existing waste management system) (BMP 4)	10	10	-
	full system (total barnyard control) (BMP 4)	75	75	-
agriculture <sup>2</sup>	grazing land protection (rotational grazing) (BMP 9)	50	25	-
resource protection & watershed planning – streambank protection <sup>1</sup>	stream protection with fencing (BMP 7)	75	75	75

<sup>1</sup> acres treated

<sup>2</sup> acres protected

<sup>3</sup> number of systems

<sup>4</sup> soil conservation water quality plan

<sup>5</sup> tons of manure reduced

<b>Category</b>	<b>Type of Watershed Model BMP</b>	<b>Reduction Efficiency N (%)</b>	<b>Reduction Efficiency P (%)</b>	<b>Reduction Efficiency TSS (%)</b>
resource protection & watershed planning – streambank protection <sup>1</sup> (continued)	stream protection w/o fencing (BMP 7)	40	40	40
	stream restoration (non-tidal) (BMP 7)	75	75	75
resource protection & watershed planning <sup>1</sup>	forest harvesting practices (BMP 5)	50	50	50
buffers <sup>1</sup>	forested (BMP 1)	48-65	70	70
	grassed (BMP 1)	35-50	53	53
cover crops <sup>1</sup>	cover crops (cereal grain) (BMP 3)	34-51	10-20	10-20
Water Quality Model BMPs <sup>6</sup>	marine pumpouts (installation)	95	95	
Water Quality Model BMPs - shoreline protection <sup>6</sup>	structural shore erosion control	75	75	75
	nonstructural shore erosion control	75	75	75
Water Quality Model BMPs – combined sewer overflows <sup>2</sup>	treatment	15	30	30
	conversion (CSO->sewer)	95	95	95

<sup>1</sup> acres treated

<sup>2</sup> nutrient load pound reduction

The simulation of a land use, for example pastureland, within a particular Watershed Model segment is not a simulation of all of the different types of pasturelands, but a single representative average pasture within that Watershed Model segment. BMP nutrient reduction efficiencies applied to pasturelands are represented with this average value and applied as a percent reduction to the portion of pastureland treated with that BMP. This BMP nutrient reduction efficiency represents a percent reduction in nutrient loading, which results from applying a BMP to the land use. Equation 1 shows this process, where a hypothetical pasture rotation BMP had a total nitrogen reduction efficiency of 10 percent, was applied to 100 acres of pasture in a Watershed Model segment, which had a total of 1,000 acres of pastureland. The reduction applied to the average pastureland simulated by the Phase IV Watershed Model would then be:

$$10 \text{ percent BMP efficiency} * \frac{100 \text{ acres treated}}{1,000 \text{ acres total}} = \text{overall 1 percent TN reduction for the average simulation of pasture} \quad (1)$$

### **Section H.2.2.1 Urban BMPs**

Urban BMPs simulated within the Phase IV Watershed Model are erosion and sediment control, extended stormwater detention (dry), pond-wetland systems, stormwater wetlands, retention ponds, stormwater retention structure conversions (dry to wet), sand filters, septic systems (pumping, connections, and denitrification), and urban nutrient management. The following section describes each of these BMPs.

#### **Section H.2.2.1.1 Erosion and Sediment Controls**

Erosion and sediment controls, including sediment ponds and silt fencing, are applied to construction sites. The Chesapeake Bay Watershed Model assumes that some portion of the urban land use is in a transitory construction phase at all times. Erosion and sediment controls reduce the high nutrient and suspended sediment loads during the transitory construction phase. Erosion and sediment controls have been in place throughout the Chesapeake Bay basin prior to the 1985 reference year, but are counted as an efficiency reduction in tributary strategies because of the substantial refinements of erosion and sediment reduction techniques, permit inspections, and practice implementation since 1985 throughout the Chesapeake Bay basin. The jurisdictions have also increased implementation of erosion and sediment controls since 1985.

Erosion and sediment controls primarily protect off-site areas from sediment runoff and nutrient pollution. There are numerous technologies that allow for the reduction of sediment from erodible lands. By retaining the soil on-site, nutrients attached to the sediment are prevented from leaving the disturbed area, thus reducing off-site impacts.

Incorporation of erosion and sediment controls result in the reduction of suspended sediment and nutrient loads from pervious urban land. Erosion and sediment controls are estimated to reduce nutrient loads from urban acres by 33 percent for total nitrogen and 50 percent for both total phosphorus and sediment.

### Section H.2.2.1.2 Stormwater Management Systems

Stormwater management systems include extended detention areas (dry basins or ponds), retention ponds (wet), stormwater wetlands (one step), pond-wetland systems (series), stormwater retrofits, stormwater conversions (conversion from dry to retention), and sand filters. Nutrient reduction is not the only benefit of stormwater management systems: they also reduce sediment transport, and control peak runoff flows. New development areas in Virginia are required to have stormwater management systems, but for a majority of the Bay basin, these stormwater management systems are for peak flows only and focus on protecting downstream banks from erosion rather than on water quality issues. The only place where stormwater management system water quality controls are required for new developments within the Bay Watershed are in Chesapeake Bay Preservation Act areas in Virginia. These stormwater management practices such as retention ponds with adequate storage and ponds which have extended detention (1 year - 24 hour design criteria) can provide significant pollutant removal, especially when coupled with wetlands components.

Stormwater management BMPs are incorporated into the Phase IV Watershed Model by applying nutrient reduction percentages to nutrient loads from pervious and impervious land areas. These reductions apply to the nutrient and suspended sediment load from land acres affected by stormwater management BMPs. The estimated percentages for each stormwater management system follow:

<b>Management System</b>	<b>TN reductions(%)</b>	<b>TP &amp; TSS reductions(%)</b>
<b>Extended detention</b> (dry basins or ponds)	25	20
<b>Retention ponds</b> (wet)	32	46
<b>Stormwater wetlands</b> (one step)	25	47
<b>Pond-wetland systems</b> (series)	29	64

Stormwater retrofits may be extended detention retention ponds, stormwater wetlands, or other water bodies designed to address peak flows and nonpoint source nutrient loads generated on existing urban land developed before stormwater management systems were required. Retrofits provide the same reductions as new stormwater management practices and may be designed to address stormwater flows and/or nutrient and sediment control.

Stormwater conversions increase nonpoint source pollution reductions from areas served by dry basins. Dry basins, without extended detention, are designed to control peak flows and provide relatively few water quality benefits. A stormwater conversion changes a detention basin to a retention pond. For a stormwater conversion, the estimated nutrient and suspended sediment load reductions are: 32 percent for total nitrogen loading, and 46 percent for both total phosphorus and total suspended sediment loading.

Sand filters are also used for the reduction of urban nutrient loads. It is estimated that sand filters reduce the total nitrogen load by 30 percent, the total phosphorus load by 45 percent, and the total suspended sediment load by 80 percent.

It is not possible to decrease the flow intensity in the Phase IV Watershed Model. Therefore, some beneficial effects of stormwater practices are not accounted for in the tracking systems. These ancillary benefits include reduction in stream channel erosion and urban stream habitat restoration.

### **Section H.2.2.1.3 Onsite Wastewater Management Systems**

For onsite wastewater management systems (OSWMS), commonly called septic systems, nutrient reductions are achieved through three types of management practices. These practices are frequent maintenance and pumping, connection of OSWMS to sewage treatment systems, and OSWMS denitrification. For all of these septic system BMPs, the nutrient reduction efficiency is applied only to nitrogen as it is assumed that phosphorus is entirely treated by OSWMS.

Public education promotes onsite wastewater management system maintenance and informs people how these systems impact the Chesapeake Bay. Whenever septic tanks are pumped and septage removed, the onsite wastewater management system has an increased capacity to remove settleable and floatable solids from the wastewater (Robillard and Martin, 1990a). Septic tank pumping promotes biological digestion of a portion of the solids and allows for storage space for the remaining undigested solid portion of the wastewater. OSWMS effluent flows out of septic tanks and into an underground soil adsorption system (field). The pumping of septic tanks is one of several measures that can be implemented to protect soil adsorption systems from clogging and failure (Robillard and Martin, 1990b). This measure reduces the nitrogen loads by an estimated 5 percent. The level of BMP implementation is reported by signatory states as the number of systems implemented. A ratio is formed of the number of pumpouts reported and the total number of septic systems. If a system fails, soil adsorption fields are often unable to adequately filter and treat wastewater, consequently non-treated septic system effluent can drain directly into ground and surface water sources.

Septic system nutrient load simulations are incorporated into the Phase IV Watershed Model as a percent reduction of the OSWMS nitrate load. This is accomplished by reducing the OSWMS nitrate load in a Watershed Data Management file in proportion to the amount of edge-of-stream nitrate load attenuated with OSWMS BMPs.

Using an average water flow of 75 gallons/person-day (gpd) for a septic tank (Salvato, 1982), a mean value of 3,940 grams/person-year for groundwater septic flow, 4,240 grams/person-year for surface flow of septic effluent, and typical surface/subsurface splits as reported by Maizel, et. al., a total nitrogen concentration of about 39 mg/l at the edge of the septic field is calculated. This concentration compares favorably with Salvato (1982) who calculated onsite wastewater management system total nitrogen concentrations of 36 mg/l. It is assumed that between the edge of septic system field nitrate loads and edge-of-river nitrate loads represented in the Phase IV Watershed Model are primarily: (1) attenuated in anaerobic saturated soils with sufficient organic carbon (Robertson, Cherry, et. al., 1991; Robertson and Cherry, 1992), (2) attenuated by



plant uptake (Brown and Thomas, 1978), or (3) attenuated in the primary through quaternary streams before the main river reach. Overall, the total attenuation is assumed to be 60%. Consequently, 40 percent of the septic system nitrate load for each model segment as reported in Maizel, et. al. (1997) is input to the major river reaches simulated by the Phase IV Watershed Model. Given the previously mentioned assumptions of a 60 percent reduction, edge-of-river loads from OSWMS are 23 mg/l of total nitrogen. Further attenuation of the OSWMS loads delivered to the Bay occurs through nutrient dynamics in the river reaches.

The connection of onsite wastewater management system to sewage lines is particularly effective in reducing OSWMS nutrient loads. Information used to estimate this option includes the number of septic systems that local governments have identified as connected to sewer systems since the base year of 1985. Septic connections reduce total nitrogen load by an estimated 55 percent which approximates an edge-of-river OSWMS nitrate load delivered to a tertiary treatment plant.

Denitrification in OSWMSs is accomplished through a sand mound system with effluent recirculation. The nitrogen load is reduced by 50 percent when denitrification is incorporated in septic systems.

#### **Section H.2.2.1.4 Onsite Wastewater Management System Loading**

Onsite wastewater management system loading information per Watershed Model segment is extracted from the National Center for Resource Innovation (NCRI) data (Maizel et al., 1997). The NCRI report (Maizel et al., 1997) provides estimates of human population and people served by septic disposal within a Watershed Model segment. Estimates of population using septic disposal through time is calculated by multiplying the ratio of the total population to the total population using septic systems by the population estimates for Chesapeake Bay Watershed Model segments (Table H.2.4 and Table H.2.5). These data in coordination with Watershed Model segment area values are used to simulate Watershed Model segment OSWMS loads (per acre and per person) to the Bay.

The septic nutrient loads are included in the HSPF simulation as a continuous time series Watershed Data Management file that inputs OSWMS nitrate (pounds/day) to model segment river reaches or to the tidal Bay. The use of a Watershed Data Management file for incorporation of septic nitrate allows for this attenuation factor to easily be changed on a model segment basis. For above fall line Watershed Model segments, OSWMS nitrate loads are input directly into the stream reach. For below fall line Watershed Model segments, there is no stream reach, so estimated OSWMS nitrate loads are delivered directly to the tidal Bay.

**Table H.2.4 Population Estimates & Projections for Chesapeake Bay Program Modeling Segments**

Watershed Model Segment	SEPTIC Pop /Total Pop	SEPTIC Est Pop in 1985	SEPTIC Est Pop in 1990	SEPTIC Est Pop in 1991	SEPTIC Est Pop in 1992	SEPTIC Est Pop in 1993	SEPTIC Est Pop in 1994	SEPTIC Est Pop in 1995	SEPTIC Prj Pop in 2000	SEPTIC Prj Pop in 2005	SEPTIC Prj Pop in 2010	SEPTIC Prj Pop in 2015	SEPTIC Prj Pop in 2020
10	0.502383	118034	117382	117819	118196	118286	118112	117689	119213	120232	121017	121468	121918
20	0.515373	254580	256453	257636	258469	258266	256997	254423	258668	260276	261353	262337	263321
30	0.259266	103444	102018	102217	102284	102198	101937	101686	100928	99567	98205	97145	96084
40	0.292036	101252	99881	100204	100344	100330	100194	99931	99161	97857	96552	95114	93676
50	0.551859	59943	57753	57791	57928	58120	58330	58377	57728	56919	56109	55903	55695
60	0.34262	77175	78182	79005	79612	80203	80688	80790	82424	84276	86127	87527	88926
70	0.538199	67915	68487	68837	69075	69924	71251	71129	71164	72170	73177	73993	74810
80	0.398305	142670	146656	148573	149771	151008	152208	152850	154474	157104	159732	161077	162421
90	0.773786	34964	35395	35644	35826	36065	36197	36295	36828	37535	38241	38940	39637
100	0.425485	108157	107767	108434	108781	109409	109669	109730	112204	114200	116194	117886	119579
110	0.332549	212609	219785	223100	225185	227366	229451	231294	233177	238031	242892	245447	248000
120	0.773204	32112	34537	35141	35470	35840	36209	36603	38709	40438	42166	43425	44687
140	0.863138	26871	28556	29169	29604	29952	30373	30779	31973	33187	34217	34999	35762
160	0.318064	37191	36316	36394	36394	36350	36321	36415	37031	37105	37160	37226	37260
170	0.608516	17002	17407	17609	17757	17948	18142	18350	18048	18366	18674	18974	19218
175	0.745706	20250	21079	21571	21912	22195	22405	22672	23163	24024	24830	25568	26211
180	0.424894	61259	64976	66416	67607	68602	69623	70572	74040	77492	80854	83414	85760
190	0.461894	80360	84753	85983	86876	87755	89171	90164	90416	92569	94723	96939	99153
200	0.575484	60982	65958	67295	68251	69312	70306	71346	75013	79186	83262	87231	91094
210	0.490847	77770	87711	90523	92983	95873	98791	101091	114055	124629	135432	142455	149422
220	0.13066	72226	82532	84240	85877	87735	89447	91067	96286	101759	107300	111811	116319
230	0.692358	54768	60954	62718	63811	64907	65950	67095	74242	79677	85115	90550	95987
235	0.65207	9295	11377	11940	12374	12955	13509	14078	14762	15955	17147	18341	19534
240	0.808588	10722	11178	11512	11665	11904	12032	12310	12041	12426	12810	13195	13579
250	0.814212	9493	10445	10792	11053	11325	11618	11906	12090	12742	13396	14048	14701
260	0.860227	26843	29318	30288	31076	31868	32689	33748	34314	36661	39006	41352	43698
265	0.583659	1722	1594	1576	1578	1580	1579	1582	1478	1474	1473	1473	1473
270	0.564725	49833	49023	49425	49556	49941	50150	50379	49049	49286	49528	50052	50577

Model Segment	Pop /Total Pop	Est Pop in 1985	Est Pop in 1990	Est Pop in 1991	Est Pop in 1992	Est Pop in 1993	Est Pop in 1994	Est Pop in 1995	Prj Pop in 2000	Prj Pop in 2005	Prj Pop in 2010	Prj Pop in 2015	Prj Pop in 2020
280	0.496574	133811	138853	140381	142119	143582	144940	146434	148967	153539	158111	162682	167255
290	0.28037	24873	27161	27803	28343	28938	29560	29832	31411	33292	35174	37068	38962
300	0.742736	33951	34762	35318	35815	36441	36772	37193	36715	37438	38164	38890	39618
310	0.825716	5699	5983	6200	6285	6483	6591	6662	6958	7290	7623	7954	8285
330	0.552381	17174	19816	20297	20658	21106	21471	21811	23528	25301	26583	27949	29313
340	0.083846	18458	21058	21680	22084	22637	23155	23607	25738	27993	29260	31187	33084
370	0.788588	2057	2211	2264	2301	2336	2368	2400	2556	2688	2803	2899	2991
380	0.658677	16607	17990	18340	18602	18802	19000	19301	20719	21749	22651	23554	24309
390	0.702874	3733	4217	4305	4347	4413	4467	4565	5039	5384	5677	5972	6237
400	0.537942	22229	23261	23442	23693	23899	24120	24290	25318	26089	26849	27465	28001
410	0.691714	42026	44735	45801	46709	47628	48488	49289	53207	56243	58839	61064	63023
420	0.474014	28169	30194	30804	31111	31556	31875	32193	34114	35876	37552	39089	40452
430	0.592752	24017	25898	26205	26553	27004	27539	27871	29446	30723	31843	32648	33226
440	0.756768	21431	21060	21118	21141	21187	21247	21267	21019	20911	20802	20838	20874
450	0.554552	104901	114836	118331	121045	122608	124941	126976	137440	144842	150090	155021	159646
470	0.340422	75617	78549	79730	80491	80982	81619	82289	84179	86137	87375	88921	90545
480	0.027694	16813	16547	16547	16465	16330	16163	16010	16078	15996	15889	15943	16004
490	0.092675	26340	27961	28381	28688	29068	29441	29741	30885	32135	32737	33601	34403
500	0.365952	62709	67640	69439	70498	71317	72620	73739	80052	85633	90852	97089	103020
510	0.461104	20131	21556	21893	22193	22578	22992	23300	24227	25277	25791	26357	26816
540	0.013827	8641	9134	9227	9278	9321	9378	9419	9818	10280	10760	11209	11642
550	0.197031	56829	67215	69069	70867	72430	73851	75087	84636	91260	97884	104508	111133
560	0.4046	37667	42685	44309	45660	47119	48928	50575	50991	53789	56589	59388	62188
580	0.850801	2891	2991	3048	3103	3123	3145	3160	3228	3333	3437	3541	3646
590	0.68712	46852	52249	53861	55350	57096	58564	60299	63003	67893	72787	77675	82566
600	0.130063	95818	101871	103500	105316	106006	106975	107980	111840	116469	121100	126230	131360
610	0.177894	27585	29945	30522	30973	31535	32112	32417	34180	36165	38150	40167	42185
620	0.322114	18892	19659	19852	20049	20385	20674	21163	21954	22720	23485	24271	25058
630	0.004755	218	229	232	237	242	246	248	249	254	260	267	273
700	0.642741	8885	8746	8802	8857	8887	8890	8930	8944	8872	8801	8740	8680
710	0.388991	34728	36838	37476	37858	38274	38689	39130	40565	42074	43582	44625	45668
720	0.263288	70784	76169	77497	78199	78983	79772	80586	85415	89245	93077	95875	98673
730	0.414658	32088	33117	33659	33955	34222	34457	34592	35054	35754	36454	36803	37152

Model Segment	Pop /Total Pop	Est Pop in 1985	Est Pop in 1990	Est Pop in 1991	Est Pop in 1992	Est Pop in 1993	Est Pop in 1994	Est Pop in 1995	Prj Pop in 2000	Prj Pop in 2005	Prj Pop in 2010	Prj Pop in 2015	Prj Pop in 2020
740	0.53121	89003	96796	99399	101087	102559	104261	105798	113522	120912	128044	134791	141030
750	0.470037	12963	13869	14216	14395	14573	14756	14913	15586	16301	17027	17561	18093
760	0.587876	23721	26207	26929	27440	27925	28532	29177	30849	32954	35286	37380	39471
770	0.932583	9392	10020	10275	10424	10616	10750	10929	11724	12387	12958	13434	13845
780	0.874629	4258	4559	4690	4798	4910	5014	5116	5582	5940	6237	6491	6713
800	0.689785	9918	10714	10993	11183	11371	11535	11704	12509	13193	13809	14327	14806
810	0.675963	5737	6003	6111	6218	6257	6320	6374	6578	6737	6907	7062	7175
820	0.681072	8971	10246	10461	10585	10761	10895	11163	12554	13549	14364	15209	15964
830	0.44829	9952	10829	11060	11093	11198	11339	11487	11840	12159	12549	12832	13116
840	0.653193	5096	5064	5046	5065	5077	5075	5053	5167	5234	5318	5368	5401
850	0.069591	2837	3150	3271	3371	3409	3491	3552	3920	4144	4265	4402	4528
860	0.012689	6413	6358	6371	6353	6315	6267	6226	6260	6251	6225	6256	6291
870	0.488961	28927	30974	31459	31890	32443	33038	33480	34814	36321	37061	37873	38533
880	0.367983	39007	42507	43494	44344	45339	46374	47206	50340	53480	55741	58628	61271
890	0.008755	4733	4841	4802	4781	4766	4725	4676	4682	4835	5088	5308	5521
900	0.016068	12052	13412	13623	13837	14001	14144	14235	15411	15938	16464	16990	17516
910	0.0599	19902	20622	20795	20841	20864	20953	21008	22046	23103	24241	25517	26742
920	0.527289	52283	59666	61454	62436	62787	63763	64808	73679	78889	84524	89875	95080
930	0.786088	2787	2888	2913	2939	2956	2969	2993	3105	3201	3297	3393	3489
940	0.889272	21174	23628	23974	24282	24879	25271	25798	28095	29856	31619	33380	35143
950	0.088801	12492	13277	13578	13833	14152	14350	14467	14525	14979	15433	15886	16340
960	0.033511	21562	23430	23540	24024	24293	24266	24275	26194	27537	28879	30270	31661
970	0.120048	3008	3600	3711	3818	3919	4009	4092	4635	5087	5539	5992	6445
980	0.525818	35540	40880	43096	44932	46218	48250	49865	51633	54808	57986	61162	64339
990	0.403513	2127	2415	2507	2566	2583	2639	2686	3000	3245	3517	3782	4031

**Table H.2.5 Septic Loading Projections for the Chesapeake Bay Program Modeling Segments**

Watershed Model Segment	Septic Load/ Person	Est Load in 1985	Est Load in 1990	Est Load in 1991	Est Load in 1992	Est Load in 1993	Est Load in 1994	Est Load in 1995	Est Load in 2000	Est Load in 2005	Est Load in 2010	Est Load in 2015	Est Load in 2020
10	9.21	1,087,092	1,081,091	1,085,116	1,088,582	1,089,415	1,087,814	1,083,913	1,097,956	1,107,335	1,114,567	1,118,722	1,122,868
20	9.09	2,314,135	2,331,155	2,341,911	2,349,482	2,347,641	2,336,107	2,312,707	2,351,290	2,365,911	2,375,698	2,384,641	2,393,589
30	9.27	958,924	945,705	947,553	948,173	947,375	944,960	942,629	935,601	922,983	910,361	900,533	890,701
40	9.16	927,469	914,907	917,868	919,147	919,027	917,777	915,370	908,316	896,366	884,417	871,245	858,073
50	9.49	568,864	548,077	548,439	549,732	551,560	553,550	554,001	547,836	540,159	532,476	530,517	528,548
60	9.41	726,215	735,690	743,438	749,144	754,712	759,278	760,238	775,607	793,037	810,453	823,627	836,794
70	9.12	619,055	624,265	627,459	629,627	637,369	649,461	648,348	648,666	657,835	667,014	674,456	681,903
80	9.27	1,322,543	1,359,491	1,377,255	1,388,361	1,399,829	1,410,958	1,416,910	1,431,959	1,456,343	1,480,704	1,493,173	1,505,627
90	9.11	318,625	322,560	324,830	326,480	328,659	329,865	330,761	335,612	342,057	348,488	354,863	361,216
100	9.28	1,003,996	1,000,382	1,006,575	1,009,794	1,015,624	1,018,037	1,018,606	1,041,570	1,060,094	1,078,602	1,094,310	1,110,030
110	9.10	1,933,910	1,999,184	2,029,333	2,048,299	2,068,137	2,087,103	2,103,873	2,121,000	2,165,145	2,209,363	2,232,603	2,255,831
120	9.12	292,762	314,876	320,374	323,377	326,747	330,116	333,704	352,907	368,669	384,424	395,907	407,411
140	9.28	249,401	265,039	270,726	274,764	277,993	281,902	285,667	296,754	308,018	317,583	324,841	331,915
160	9.31	346,292	338,147	338,873	338,870	338,461	338,189	339,068	344,805	345,492	346,004	346,617	346,931
170	10.28	174,794	178,961	181,032	182,558	184,523	186,512	188,658	185,549	188,821	191,980	195,064	197,579
175	9.85	199,509	207,679	212,528	215,886	218,678	220,750	223,372	228,214	236,700	244,635	251,908	258,242
180	9.11	558,026	591,893	605,003	615,852	624,917	634,217	642,868	674,459	705,903	736,523	759,850	781,215
190	9.31	748,266	789,172	800,630	808,943	817,123	830,314	839,557	841,901	861,952	882,011	902,638	923,261
200	9.45	576,399	623,435	636,070	645,111	655,141	664,535	674,364	709,019	748,466	786,994	824,510	861,020
210	9.12	709,503	800,197	825,852	848,287	874,658	901,280	922,259	1,040,533	1,136,994	1,235,551	1,299,627	1,363,188
220	9.08	655,995	749,599	765,114	779,985	796,857	812,411	827,126	874,521	924,231	974,557	1,015,536	1,056,475
230	9.55	522,962	582,033	598,878	609,317	619,782	629,739	640,674	708,914	760,818	812,742	864,640	916,557
235	9.20	85,464	104,615	109,789	113,782	119,124	124,215	129,449	135,739	146,705	157,671	168,644	179,616
240	9.62	103,177	107,566	110,780	112,250	114,553	115,783	118,460	115,868	119,572	123,276	126,972	130,676
250	9.55	90,643	99,732	103,051	105,539	108,136	110,935	113,687	115,444	121,671	127,914	134,134	140,369
260	9.57	256,804	280,490	289,765	297,303	304,883	312,734	322,873	328,289	350,740	373,174	395,617	418,060
265	11.35	19,555	18,097	17,898	17,918	17,938	17,931	17,964	16,778	16,738	16,719	16,719	16,719
270	9.69	482,737	474,892	478,787	480,051	483,787	485,806	488,027	475,144	477,436	479,777	484,859	489,947

Model Segment	Load/ Person	Est Load in 1985	Est Load in 1990	Est Load in 1991	Est Load in 1992	Est Load in 1993	Est Load in 1994	Est Load in 1995	Est Load in 2000	Est Load in 2005	Est Load in 2010	Est Load in 2015	Est Load in 2020
280	9.37	1,253,542	1,300,773	1,315,087	1,331,368	1,345,077	1,357,796	1,371,793	1,395,523	1,438,348	1,481,178	1,524,003	1,566,838
290	9.26	230,400	251,595	257,543	262,550	268,053	273,822	276,343	290,968	308,392	325,821	343,365	360,916
300	9.55	324,121	331,864	337,168	341,912	347,889	351,052	355,072	350,506	357,405	364,339	371,274	378,223
310	9.16	52,227	54,831	56,821	57,600	59,409	60,400	61,051	63,767	66,809	69,859	72,893	75,927
330	8.97	154,019	177,714	182,028	185,268	189,291	192,561	195,612	211,009	226,911	238,410	250,656	262,887
340	9.06	167,287	190,855	196,488	200,148	205,166	209,857	213,957	233,269	253,706	265,185	282,656	299,843
370	9.02	18,560	19,955	20,432	20,767	21,080	21,371	21,663	23,065	24,254	25,293	26,161	26,994
380	9.23	153,206	165,967	169,193	171,612	173,459	175,288	178,065	191,149	200,646	208,971	217,303	224,267
390	9.26	34,580	39,059	39,879	40,270	40,876	41,383	42,288	46,677	49,874	52,589	55,317	57,771
400	9.24	205,288	214,822	216,496	218,811	220,709	222,751	224,321	233,819	240,934	247,953	253,642	258,595
410	9.20	386,698	411,629	421,437	429,794	438,247	446,158	453,535	489,579	517,520	541,407	561,876	579,901
420	9.03	254,466	272,759	278,270	281,045	285,061	287,943	290,821	308,172	324,092	339,229	353,112	365,427
430	9.25	222,107	239,501	242,340	245,558	249,729	254,674	257,749	272,314	284,122	294,482	301,921	307,271
440	10.01	214,543	210,831	211,415	211,642	212,104	212,702	212,907	210,422	209,339	208,248	208,611	208,968
450	9.05	949,419	1,039,336	1,070,976	1,095,534	1,109,683	1,130,793	1,149,218	1,243,917	1,310,912	1,358,412	1,403,042	1,444,901
470	9.03	682,700	709,175	719,837	726,712	731,138	736,891	742,937	760,004	777,679	788,864	802,820	817,481
480	12.72	213,820	210,437	210,442	209,403	207,686	205,555	203,619	204,473	203,441	202,076	202,756	203,537
490	9.36	246,504	261,674	265,604	268,478	272,042	275,529	278,335	289,044	300,744	306,379	314,464	321,971
500	9.17	575,266	620,500	637,003	646,722	654,235	666,187	676,449	734,363	785,562	833,441	890,659	945,068
510	9.04	181,999	194,880	197,932	200,641	204,122	207,861	210,646	219,034	228,522	233,174	238,285	242,437
540	11.38	98,366	103,969	105,035	105,607	106,102	106,749	107,215	111,761	117,023	122,479	127,597	132,516
550	9.08	516,099	610,423	627,259	643,585	657,776	670,685	681,910	768,627	828,787	888,947	949,103	1,009,265
560	9.56	360,269	408,263	423,796	436,717	450,668	467,974	483,732	487,702	514,470	541,249	568,021	594,800
580	9.70	28,034	28,999	29,561	30,089	30,287	30,501	30,641	31,301	32,316	33,331	34,337	35,352
590	9.28	434,880	484,971	499,934	513,755	529,967	543,590	559,694	584,791	630,182	675,605	720,977	766,381
600	9.24	885,383	941,306	956,365	973,145	979,520	988,474	997,758	1,033,427	1,076,202	1,118,987	1,166,391	1,213,797
610	9.09	250,860	272,324	277,570	281,673	286,785	292,033	294,800	310,835	328,886	346,942	365,287	383,632
620	9.52	179,808	187,114	188,948	190,821	194,025	196,769	201,429	208,958	216,243	223,524	231,011	238,498
630	9.12	1,990	2,085	2,117	2,160	2,202	2,240	2,260	2,268	2,320	2,372	2,430	2,488
700	9.28	82,409	81,127	81,646	82,153	82,427	82,457	82,832	82,964	82,296	81,634	81,068	80,507
710	9.10	322,123	341,689	347,610	351,150	355,010	358,864	362,948	376,262	390,254	404,242	413,919	423,593
720	9.28	644,395	693,416	705,501	711,891	719,032	726,213	733,629	777,582	812,457	847,336	872,808	898,280
730	9.18	297,906	307,465	312,492	315,241	317,720	319,899	321,154	325,439	331,941	338,439	341,685	344,922

Model Segment	Load/ Person	Est Load in 1985	Est Load in 1990	Est Load in 1991	Est Load in 1992	Est Load in 1993	Est Load in 1994	Est Load in 1995	Est Load in 2000	Est Load in 2005	Est Load in 2010	Est Load in 2015	Est Load in 2020
740	9.26	817,179	888,729	912,633	928,123	941,643	957,270	971,384	1,042,300	1,110,153	1,175,635	1,237,577	1,294,865
750	9.13	120,102	128,498	131,708	133,367	135,022	136,716	138,170	144,406	151,026	157,754	162,697	167,631
760	9.03	216,546	239,246	245,834	250,498	254,928	260,465	266,356	281,615	300,834	322,119	341,237	360,328
770	9.09	84,780	90,446	92,752	94,099	95,825	97,037	98,654	105,834	111,820	116,972	121,265	124,978
780	9.02	38,715	41,451	42,644	43,630	44,648	45,595	46,517	50,756	54,009	56,713	59,019	61,039
800	9.13	89,464	96,638	99,158	100,869	102,567	104,042	105,573	112,833	118,999	124,562	129,228	133,546
810	9.35	52,383	54,808	55,802	56,771	57,135	57,709	58,203	60,067	61,517	63,066	64,480	65,511
820	9.27	83,907	95,832	97,838	99,004	100,648	101,902	104,406	117,414	126,727	134,345	142,251	149,309
830	9.21	92,261	100,390	102,526	102,833	103,810	105,115	106,486	109,756	112,715	116,327	118,957	121,588
840	9.76	46,920	46,625	46,457	46,631	46,746	46,728	46,523	47,570	48,189	48,959	49,422	49,729
850	9.47	27,695	30,751	31,927	32,905	33,274	34,079	34,674	38,259	40,454	41,636	42,970	44,202
860	14.05	60,744	60,224	60,346	60,169	59,814	59,362	58,968	59,289	59,212	58,964	59,257	59,591
870	9.00	406,399	435,154	441,962	448,020	455,790	464,143	470,359	489,092	510,277	520,664	532,074	541,341
880	9.18	351,086	382,591	391,474	399,128	408,084	417,397	424,883	453,098	481,354	501,710	527,690	551,478
890	13.54	43,454	44,452	44,088	43,897	43,756	43,387	42,935	42,984	44,391	46,716	48,731	50,692
900	10.33	163,222	181,650	184,503	187,402	189,625	191,564	192,794	208,726	215,852	222,978	230,105	237,231
910	9.79	205,607	213,054	214,838	215,310	215,550	216,472	217,035	227,765	238,685	250,443	263,617	276,273
920	9.52	511,786	584,056	601,554	611,165	614,607	624,156	634,386	721,217	772,223	827,378	879,757	930,711
930	9.62	26,533	27,491	27,730	27,977	28,142	28,262	28,486	29,556	30,469	31,382	32,295	33,207
940	9.43	203,597	227,198	230,524	233,491	239,229	243,000	248,062	270,149	287,088	304,036	320,967	337,924
950	9.40	117,820	125,229	128,065	130,467	133,476	135,344	136,453	136,995	141,275	145,556	149,836	154,116
960	9.72	202,632	220,190	221,228	225,774	228,303	228,049	228,131	246,165	258,783	271,401	284,470	297,540
970	9.09	29,221	34,977	36,056	37,089	38,078	38,945	39,760	45,027	49,423	53,819	58,215	62,612
980	9.36	322,971	371,506	391,642	408,324	420,012	438,481	453,155	469,225	498,078	526,959	555,816	584,687
990	9.44	19,897	22,600	23,461	24,004	24,167	24,688	25,133	28,067	30,362	32,907	35,384	37,721

### Section H.2.2.1.5 Urban Nutrient Management

Urban areas are divided into pervious and impervious urban areas within the Chesapeake Bay Watershed Model. Pervious urban areas account for suburban areas, parks, lawns, and areas in which water is able to percolate through the soil. Alternatively, impervious urban land are areas such as roads, paved lots, and rooftops where water is unable to percolate through the soil profile. These lands use groups are derived from Chesapeake Bay Program Land Use (CBPLU) categories and are described in Watershed Model Appendix E: Watershed Land Uses and Model Linkages to the Airshed and Estuarine Models. The following equations use Chesapeake Bay Program Land Use estimates to calculate the two categories of urban areas:

(2)

$$\begin{aligned} \text{Pervious Urban} = & (\text{CBPLU High Intensity Urban} * 0.15) + (\text{CBPLU Low Intensity Urban} * 0.6) \\ & + (\text{CBPLU Herbaceous Urban} * 0.9) + (\text{CBPLU Urban} * 0.9) \\ & + (\text{CBPLU Exposed} * 0.6) \end{aligned}$$

(3)

$$\begin{aligned} \text{Impervious Urban} = & (\text{CBPLU High Intensity Urban} * 0.85) + (\text{CBPLU Low Intensity Urban} * 0.4) \\ & + (\text{CBPLU Herbaceous Urban} * 0.1) + (\text{CBPLU Urban} * 0.1) \\ & + (\text{CBPLU Exposed} * 0.4) \end{aligned}$$

Generally, on a portion of pervious urban acres including some lawns, golf courses, and portions of park land, intensive turf management practices are applied. For these areas, an estimated recommended fertilizer application is 130 pounds of nitrogen/acre. A portion of the pervious urban areas has little or no turf maintenance and only has fertilizer applied once every three years, if at all. These areas may include lawns, medians of highways, roadside rights of way, and portions of parks. Considering the differences in the amount of fertilizer applied to various types of pervious land and the limitation of the use of the various types of urban land use averaged to represent a single urban land use, an average fertilizer application of 50 pounds of nitrogen/acre/year is applied to all pervious land within the Phase IV Watershed Model.

Figure H.2.1 shows how fertilizer nutrient application rates are determined for pervious urban areas. Fertilizer is usually applied during the spring and early fall. For this reason, the timing of fertilizer applications are split into eight periods each with a distribution of 10 days. These applications begin on the following days and last for 10 days; March 9, April 9, May 9, June 9, July 9, August 9, September 9, and October 9. The application rates of fertilizer, both  $\text{NO}_3$  and  $\text{NH}_4$ , are illustrated in Figure H.2.2.

With the implementation of tributary strategies, urban nutrient management leads to a reduction of urban fertilizer applied. Urban nutrient management involves public education (targeting urban/suburban residents and businesses) to encourage reduction of excessive fertilizer use. The CBP Nutrient Subcommittee's Tributary Strategy Workgroup has estimated that urban nutrient management reduces nitrogen loads by 17 percent and phosphorus loads by 22 percent.



Figure H.2.1 Determining Fertilizer Nutrient Application Rates For Pervious Urban Areas

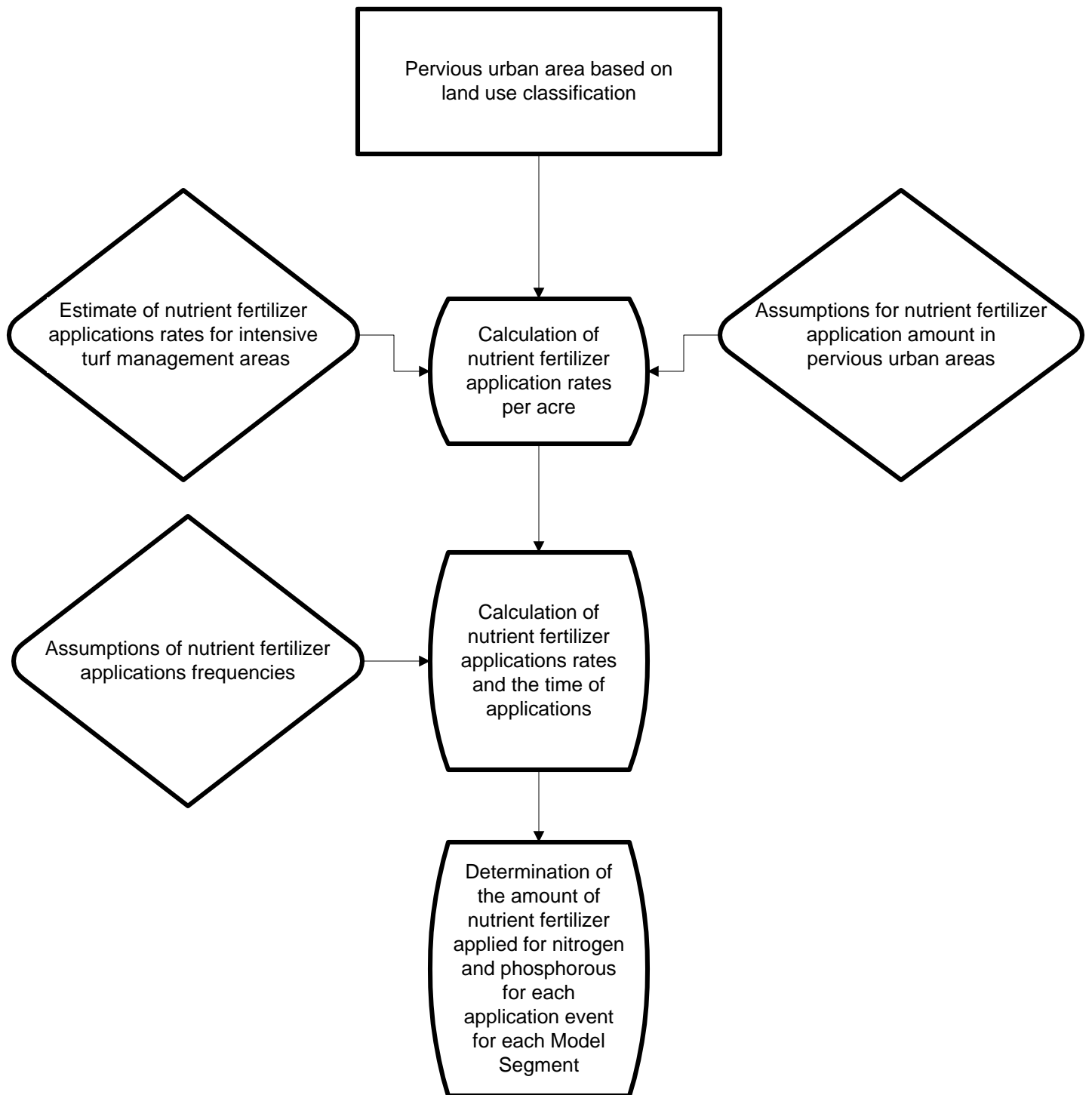
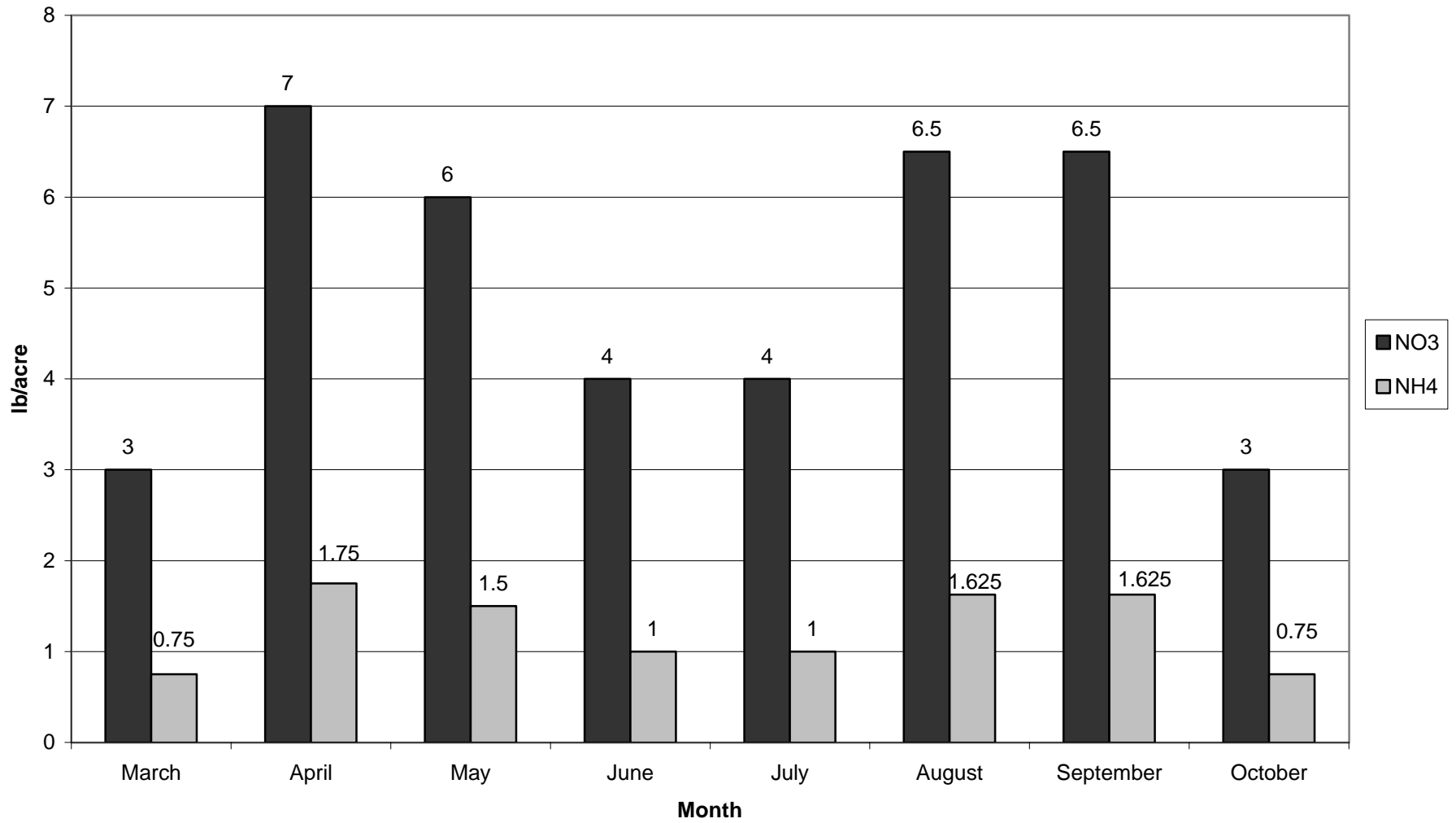

Figure H.2.2 Fertilizer Application to the Phase IV Watershed Model for Pervious Urban Land



## **Section H.2.2.2 Agriculture/Silviculture BMPs**

The types of agricultural/silvicultural BMPs included in the Chesapeake Bay Watershed Model simulations are: cropland nutrient management, soil conservation water quality plan implementation, animal waste BMPs, barnyard runoff control, rotational grazing, streambank protection, forest harvesting BMPs, nutrient management plans, forested and grass buffer strips, and cover crops. The following describes the agricultural/silvicultural BMPs simulated within the Phase IV Watershed Model.

### **Section H.2.2.2.1 Cropland Nutrient Management**

Cropland nutrient management is simulated (for each Watershed Model segment) through the net pound reduction of fertilizers applied to conventional tillage, conservation tillage, and hayland acres (Figure H.1.1, Box G, page 2). Fertilizer reductions are enacted as a part of cropland nutrient management in order to only apply nutrients at rates that ensure adequate soil fertility for crop production, thus reducing the availability of excess nutrients to runoff waters. The Phase IV Watershed Model accounts for these cropland nutrient management practices by simulating “edge-of-stream” nutrient loading according to the reduction of fertilizer nutrients applied to the land. The nutrient management application rates are implemented on the land according to the appropriate agronomic rate for each crop, with a minimum reduction of 10 percent. These nutrient application pound reductions are determined by a Watershed Model segment Cropland Mass Balance (Figure H.2.3) and vary between Watershed Model segments. For this mass balance, Watershed Model segment-specific maximum nutrient fertilizer reductions are determined from an analysis of available nutrients versus expected crop uptake. Nutrient reduction efficiencies range from 5-39 percent for nitrogen and 5-35 percent for phosphorous when calculated from nutrient fertilizer pound reductions.

For each Watershed Model segment, cropland nutrient management reductions are simulated using the percentage of acres under nutrient management. For example, if nutrient management is implemented on 100 percent of the cropland acres in a given Watershed Model segment and an estimated reduction of 60 pounds/acre nitrogen is realized, then the fertilizer reduction would be 60 pounds/acre for nitrogen for all acres under nutrient management. However, if only 25 percent of the acres are under nutrient management, the resulting fertilizer reduction would be 60 pounds/acre multiplied by 25 percent or 15 pounds/acre.

### **Section H.2.2.2.2 Soil Conservation and Water Quality Plan**

Soil conservation and water quality plans are comprehensive plans that address natural resource management concerns on agricultural lands and utilize Best Management Practices to control erosion and runoff. A USDA professional and/or a Soil Conservation District employee assists in developing these plans at the request of a landowner. They work with farmers to determine which BMPs and/or systems are needed to address specific erosion and/or runoff problems on their farms. Together these practices control erosion (within acceptable levels) in a manner compatible with the farm operation and cropping systems. Soil conservation and water quality plans are based on current farming objectives and should be reviewed and/or revised if changes

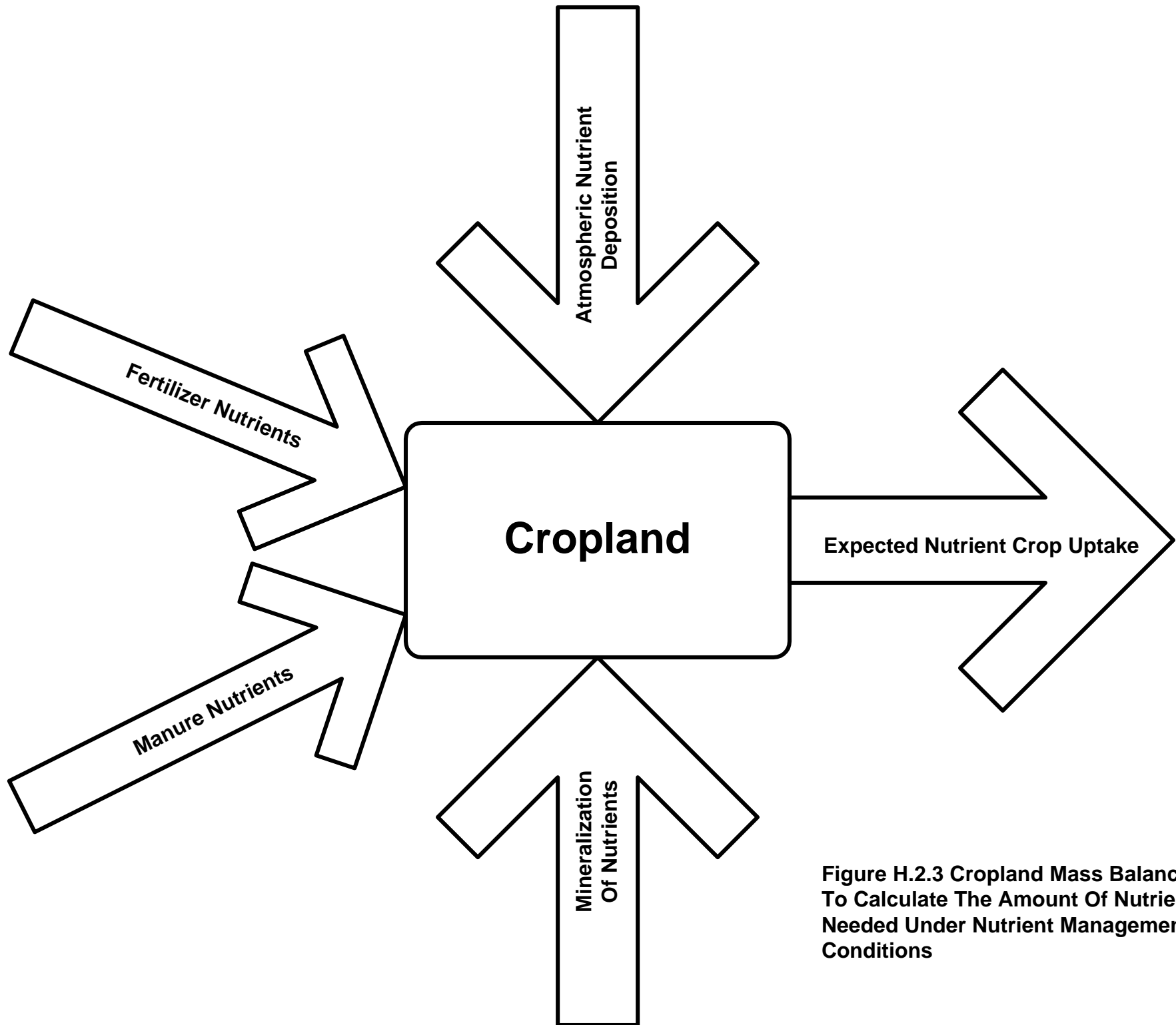

Figure H.2.3 Cropland Mass Balance Used To Calculate The Amount Of Nutrients Needed Under Nutrient Management Conditions

occur. Nutrient reductions are only one of many benefits derived from soil conservation and water quality plans, other benefits include, but are not limited to, better soil quality (therefore better crop yields), the establishment of constructed ponds, and the enhancement of wildlife and plant habitats.

Soil conservation and water quality plans are incorporated into the Phase IV Watershed Model through a reduction of sediment loss from conventional and conservation tillage, and pasture and hay croplands. These plans reduce nutrient and suspended sediment loading from each land use.

The effectiveness of soil conservation and water quality plans varies between land uses. Therefore, reductions in nutrient and suspended sediment loads vary between land uses.

The estimated reductions by landuse as effected by soil conservation and water quality plans follows:

<b>Landuse</b>	<b>TN reductions(%)</b>	<b>TP &amp; TSS reductions(%)</b>
<b>Conventional tillage</b>	10	40
<b>Conservation tillage</b>	4	8
<b>Hayland</b>	4	8
<b>Pastureland</b>	20	14

### **Section H.2.2.2.3 Animal Waste Management Systems**

Agricultural livestock and farm animals produce manure, and consequentially nutrient flow in to water supplies which directly impact the Chesapeake Bay water quality (Ritler and Scarborough, 1996; Evanylo, 1995). Understanding such an influence is important in modeling nutrient loads from land uses to the Bay, both from surface and subsurface flow (Johnson and Parker, 1993). Nutrients in manure are a vital resource and can be collected for application to cropland (Krider, 1992; Graves 1986).

Manure from agricultural livestock may either be voided in confined areas or unconfined areas (Gilbertson, 1979). Within the Phase IV Watershed Model, manure voided in unconfined areas is assumed to occur in pasturelands. The effect of confined animal waste management systems are calculated by adjusting the percentage of manure between two types of confined groups (confined/susceptible to runoff and confined/susceptible to runoff with BMPs able to be implemented). This calculation allows for some of the animal waste to always be susceptible to runoff (assuming that the BMP efficiency of animal waste and confinement systems is never 100 percent efficient).

Confined animal waste management system calculations are incorporated into Watershed Model input files by adjusting manure acres per Watershed Model segment. A manure acre is defined as 145 Animal Units (AUs) in the confined/susceptible to runoff grouping. Figure H.2.4 outlines how manure acres are obtained and later incorporated into the Phase IV Watershed Model. The Phase IV Watershed Model simulates the effect of Animal Waste System Best Management Practices (AWSBMP) through a reduction in manure acres. These manure acres are areas of

**Figure H.2.4 Calculating Manure Acres And Their Incorporation Into The Watershed Model**

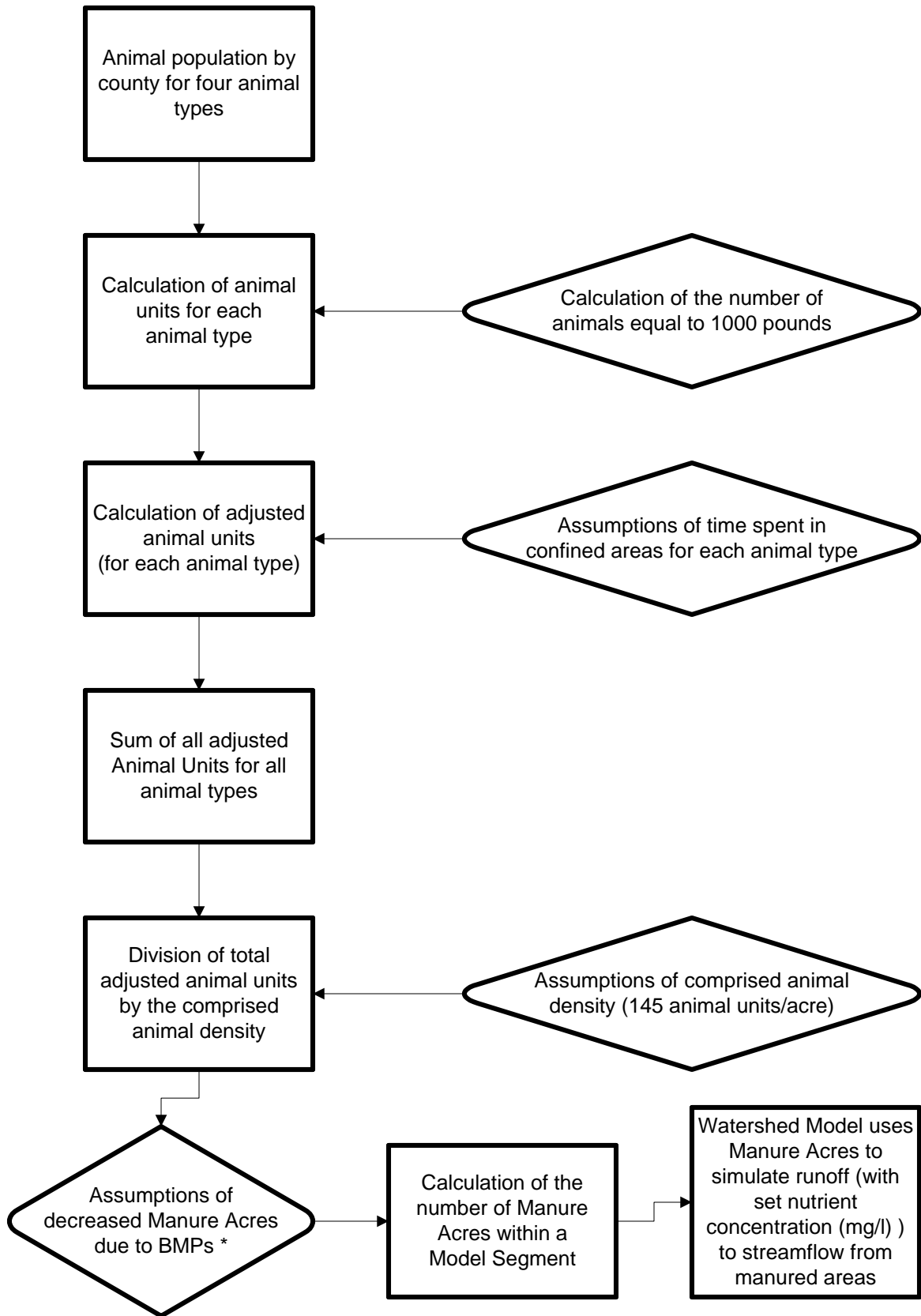

\* Not used during Reference Watershed Model simulations, but was applied for BMPs in Watershed Model Progress simulations.

**Figure H.2.5 Manure Mass Balance For Each Watershed Model Segment**

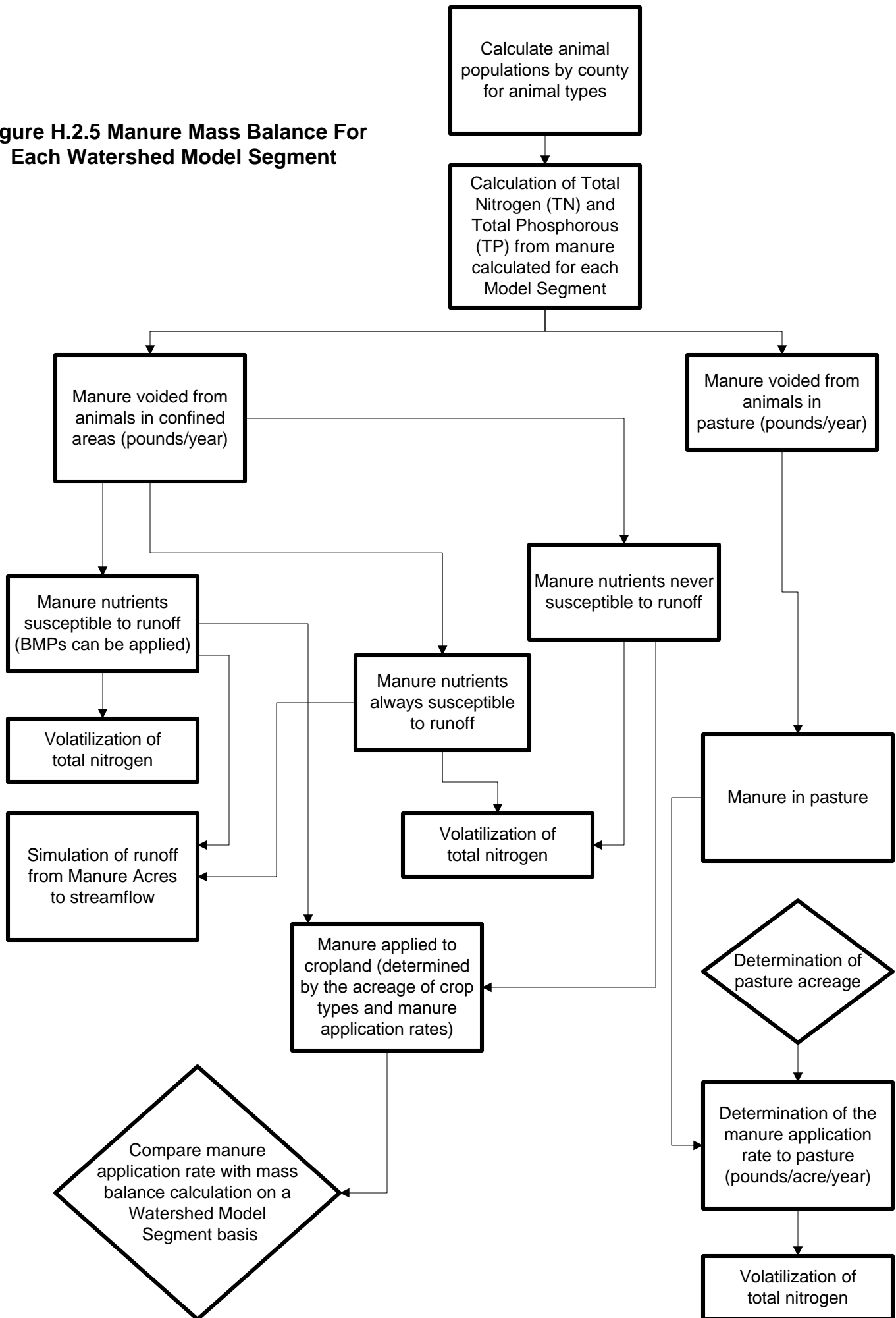

high concentrations of confined animals in which a large amount of nutrient load runoff occurs. Manure acres are representative of all portions of manure management, including manure in feedlots, production houses, processing centers, collection practices, and leakage from holding facilities.

Manure produced in confined areas can be properly or improperly stored (Loser and Hogan 1989). Animal waste management systems are designed for the proper handling, storage, and utilization of wastes generated from animal confinement operations. These systems include a means of collecting wastes and wash water from confinement areas into appropriate waste storage structures. Waste management facilities take on many forms based on the animal type and handling method (i.e., solid, slurry, and liquid). Lagoons, ponds, and concrete tanks are used for the treatment and/or storage of liquid wastes. Storage sheds or pits are commonly used to store solid wastes. Adequate storage allows operators to apply manure to their land when crops can utilize the nutrients, and when the soil and weather conditions are appropriate. Animal waste management systems not only provide major nutrient reduction benefits, but also greatly reduce a farmer's need for chemical fertilizers.

The influence that agricultural livestock and farm animals have on the Chesapeake Bay Watershed is best understood by determining a mass balance of manure for each Watershed Model segment. This manure mass balance distributes manure nutrients voided into four groups: confined/never susceptible to runoff, confined/susceptible to runoff, confined/susceptible to runoff with BMPs able to be implemented, and pasture (Table H.2.6). This Manure mass balance (Figure H.2.5) uses estimated populations of animal types within each Watershed Model segment and assumes average nutrient levels in the amounts of manure voided for each animal type (Table H.2.7) (Palace, 1997). This mass balance includes a modification in the simulation of pastureland through the addition of manure in the special action block, a simulation of ammonia volatilization, and a seasonal variation of the first-order rate constant to describe plant uptake.

Different animal species create varied volumes of manure with distinct nutrient concentrations. Within the Phase IV Watershed Model, four types of animals are included in manure mass balance calculations. These animal types are beef, dairy, swine, and poultry (which include poultry layers, broilers, and turkeys). Horse and sheep populations were not included in the manure mass balance. To estimate the amount of manure voided in a Watershed Model segment, an animal unit is defined as 1000 pounds of animal weight. One animal unit corresponds to 0.71 dairy cows, one beef cow, five swine, 250 poultry layers, 500 poultry broilers, or 100 turkeys. Animal populations were derived for each Watershed Model segment from the 1992 Agricultural Census, published by the U.S. Department of Commerce and the Bureau of the Census for the six states within the Chesapeake Bay basin. The percentage of area in a Watershed Model segment for each county is used to decide the proportion of animal units within a Watershed Model segment. Figure H.2.6 shows the total animal units per county in the Chesapeake Bay Watershed.

Animal waste management system nutrient reductions for dairy/beef/swine operations have been estimated by the Chesapeake Bay Program Nutrient Subcommittee's Tributary Strategy Workgroup to be 80 percent for nitrogen and phosphorus, assuming that an animal waste system



**Table H.2.6 Distribution of Total Nitrogen from Manure for Each Watershed Model (WSM) Segment in the Manure Mass Balance Calculation for the Phase IV Watershed Model**

<b>Animal Type</b>	<b>Confined (Susceptible to runoff)</b>	<b>Confined (Susceptible to runoff) (BMPs can be implemented)</b>	<b>Confined (Never susceptible to runoff)</b>	<b>Pasture</b>
Dairy	0.20	0.80	0.00	0.00
Beef (WSM Segment without snow)	0.00	0.00	0.00	1.00
Beef (WSM Segment with snow)	0.04	0.16	0.00	0.80
Swine	0.20	0.80	0.00	0.00
Poultry (layers)	0.01	0.14	0.85	0.00
Poultry (broilers)	0.01	0.14	0.85	0.00
Turkeys	0.01	0.14	0.85	0.00

**Table H.2.7 Estimated Quantities of Voided Manure from Livestock and Poultry (Normalized to 1,000 pounds of animal body weight) (Gilbertson, 1979)**

<b>Animal Type</b>	<b>Animals/ Animal Units</b>	<b>Wet Manure Voided (tons/year)</b>	<b>Total Phosphorous (pounds/year)</b>	<b>Total Nitrogen (pounds/year)</b>
Dairy	0.71	14.90	21.00	123.00
Beef	1.00	6.70	18.00	61.00
Swine	5.00	11.70	37.00	160.00
Poultry (layers)	250.00	9.70	100.00	235.00
Poultry (broilers)	500.00	13.10	110.00	390.00
Turkeys	100.00	10.20	84.00	304.00



treats 145 animal units (or one manure acre). Using the same 145 animal unit assumption, nutrient reductions for poultry animal waste systems have been determined to be 14 percent for nitrogen and phosphorus. These animal waste management system BMP efficiencies are used within the Phase IV Watershed Model to simulate the amount of nutrient reduction obtained with these management practices.

Estimated BMP efficiencies were developed separately for livestock (primarily dairy and swine) and poultry waste systems. Livestock manure must be stockpiled or spread daily if no storage system is available, resulting in a high potential for nutrient pollution to ground and surface water sources. On the other hand, poultry manure remains in the production house for a majority of the time. Small amounts of manure are removed with each flock (approximately every seven weeks for broilers), and the entire production house is cleaned approximately every two years. Poultry manure is relatively dry so if it is properly stacked outside, the potential for nutrient loss is less than that of livestock waste.

It is assumed within the Phase IV Watershed Model that dairy are in confined areas 100 percent of the time. Dairy are further divided into the three confined groups as follows: 20 percent in confined/susceptible to runoff, 80 percent confined/susceptible to runoff with BMPs able to be implemented, and 0 percent confined/never susceptible to runoff.

Beef are assumed to be in pasture 100 percent of the time, except for Watershed Model segments where snow covers the ground a large portion of the winter. These areas receiving snow tend to have beef cattle housed in feed lots or confined areas. Within these Watershed Model segments, it was decided that beef should be calculated in the pasture for 80 percent of the time, as opposed to 100 percent. According to this assumption, beef are in confined areas 20 percent of the year (4 percent of the total time in confined/susceptible to runoff, and 16 percent in confined/susceptible to runoff with BMPs able to be implemented). This assumption is incorporated into the Phase IV Watershed Model, based on the assumption that cattle spend 292 days a year in the field, starting March 1 and ending December 17.

Within the Phase IV Watershed Model, swine are in confined areas 100 percent of the time. Swine are further divided into the three confined groups as follows: 1 percent in confined/susceptible to runoff, 14 percent confined/susceptible to runoff with BMPs able to be implemented, and 85 percent confined/never susceptible to runoff.

Throughout the Watershed Model Scenarios, it is assumed that all poultry (including poultry layers, poultry boilers, and turkeys) are found in confined areas 100 percent of the time. Poultry are further divided into the three confined groups as follows: 1 percent in confined/susceptible to runoff, 14 percent confined/susceptible to runoff with BMPs able to be implemented, and 85 percent confined/never susceptible to runoff. The amount of total nitrogen in pounds per year for each of these animal groups are presented in Tables H.2.8-H.2.11.

**Table H.2.8 Manure in All Confined Areas**

Model Segment	Cattle (lbs/yr)	Dairy (lbs/yr)	Swine (lbs/yr)	Poultry (layers) (lbs/yr)	Poultry (broilers) (lbs/yr)	Turkeys (lbs/yr)	TN in Confined Areas (lbs/yr)
10	0	7,412,860.77	322,159.59	238.86	500.88	727.41	7,736,487.51
20	0	20,222,592.93	207,013.45	30,389.97	830.86	1,661.31	20,462,488.53
30	0	6,171,144.32	148,914.95	1,396.21	739.15	469.3	6,322,663.94
40	0	1,440,062.40	844,851.76	6,575.97	319,392.10	81,921.46	2,692,803.69
50	0	1,023,546.70	164,450.69	6,605.97	1,218.27	334.53	1,196,156.17
60	0	4,916,456.66	526,983.66	6,855.71	28,105.85	1,214.14	5,479,616.02
70	0	2,315,094.50	670,308.29	2,244.39	440,288.10	195,185.63	3,623,120.91
80	0	7,994,961.58	3,683,503.72	1,489,409.28	2,024,146.03	975,150.11	16,167,170.72
90	0	2,849,960.38	360,682.36	1,873.52	385.39	22,682.22	3,235,583.86
100	0	8,705,662.44	1,543,286.86	227,551.04	1,505,299.42	431,594.87	12,413,394.62
110	0	7,427,194.61	5,057,592.49	3,250,559.82	2,017,600.36	1,541,127.58	19,294,074.86
120	0	2,730,182.08	2,044,870.19	2,685,280.77	963,108.71	113,621.55	8,537,063.30
140	0	1,660,540.52	1,295,302.63	1,231,383.72	464,423.96	166,811.26	4,818,462.09
160	0	1,348,090.20	118,845.38	9,492.56	742,283.32	197,534.59	2,416,246.05
170	0	169,339.11	146,311.24	495,738.50	3,729,548.87	3,660,889.95	8,201,827.67
175	0	952,246.82	194,616.55	635,875.69	1,683,328.68	29,928.15	3,495,995.89
180	0	3,800,172.50	492,393.41	447,701.44	44,463.15	46,114.35	4,830,844.86
190	0	4,114,876.79	391,645.93	1,629,929.04	10,467,233.30	11,524,395.63	28,128,080.69
200	0	2,982,049.73	321,144.63	866,400.63	6,173,757.54	6,820,604.65	17,163,957.17
210	0	5,529,145.89	310,694.79	614,547.22	7,063.78	208,278.49	6,669,730.17
220	0	953,376.40	50,912.90	13,414.70	200.23	212.09	1,018,116.31
230	0	1,836,824.62	223,921.69	3,968.38	26,576.79	4,848.81	2,096,140.29
235	0	96,007.70	8,725.23	292.38	0	0	105,025.31
240	0	9,535.27	18,768.86	346.41	0	0	28,650.55
250	0	185,088.58	37,997.56	72.66	0	0	223,158.81
260	0	228,796.41	69,541.06	110.18	95,158.54	2.28	393,608.47
265	0	1,230.38	1,240.63	136.33	0	99,235.86	101,843.21
270	0	1,283,631.05	91,132.65	169,058.98	194,525.15	1,378,804.11	3,117,151.94
280	0	653,093.29	295,841.88	176,778.42	1,792,610.18	13,517.48	2,931,841.26
290	0	88,400.78	79,414.32	41,364.93	242,333.21	22.48	451,535.71
300	0	918,394.17	139,784.61	86,679.14	2,603,681.72	0	3,748,539.65
310	0	57,327.77	35,211.53	54.09	140,695.87	0	233,289.26
330	0	120,677.81	16,623.40	370.75	63.12	0	137,735.09
340	0	118,124.63	35,945.64	673.86	56.7	44.5	154,845.33
370	0	93,375.90	11,761.72	8.22	4.86	7.73	105,158.44
380	0	698,781.38	208,409.68	5,015.42	924,194.74	21.91	1,836,423.14
390	0	83,697.71	17,443.20	28.58	322,871.43	0	424,040.92
400	0	399,939.65	251,239.32	3,878.23	4,325,250.39	10.89	4,980,318.47
410	0	326,055.85	939,231.02	283,889.04	15,246,760.10	30.73	16,795,966.74
420	0	8,301.04	201,318.09	334,346.27	5,440,244.44	0	5,984,209.84
430	0	53,941.46	991,424.01	300,251.60	14,667,499.31	0	16,013,116.37
440	0	0	36,999.71	39.25	1,061,254.22	0	1,098,293.17
450	0	3,380,971.35	1,558,345.31	1,979,264.71	705,919.77	123,033.42	7,747,534.56
470	0	550,109.10	140,794.82	79,045.74	1,538.59	7,901.05	779,389.30
480	0	66,937.86	19,783.98	1,236.75	0	0	87,958.60
490	0	52,585.01	18,925.13	785.19	17.94	68.11	72,381.38
500	0	31,514.26	161,515.00	3,369.56	78.36	637.06	197,114.25

Model Segment	Cattle (lbs/yr)	Dairy (lbs/yr)	Swine (lbs/yr)	Poultry (layers) (lbs/yr)	Poultry (broilers) (lbs/yr)	Turkeys (lbs/yr)	TN in Confined Areas (lbs/yr)
510	0	0	2,961.32	154.94	2.01	36.4	3,154.67
540	0	57,993.77	16,673.59	589.11	29.36	0	75,285.83
550	0	525,324.65	13,279.39	1,310.66	62.83	91.38	540,068.90
560	0	30,914.18	68,466.39	353.92	0	0	99,734.49
580	0	20.79	0.77	0	0	0	21.56
590	0	247,547.01	136,863.13	478.36	48,191.41	18.62	433,098.53
600	0	4,394.74	1,423,526.95	1,479.72	263,997.19	0	1,693,398.61
610	0	33,739.42	10,564.61	74.1	24,288.61	0	68,666.74
620	0	338.94	427,633.17	0	192,884.45	0	620,856.56
630	0	4,609.62	3,936.80	0	448.66	0	8,995.08
630	0	0	0	0	0	0	0
700	0	1,144,317.87	22,542.18	38.86	33.6	34.06	1,166,966.58
710	0	2,472,554.19	1,921,256.45	2,309,305.86	854,727.30	142,882.81	7,700,726.62
720	0	7,207,546.03	5,339,553.40	7,185,820.38	2,635,584.48	218,313.35	22,586,817.64
730	0	4,616,116.89	1,451,561.49	952,254.30	213,103.18	179,450.53	7,412,486.39
740	0	2,978,529.23	1,064,117.24	259,298.93	17,229.78	8,717.14	4,327,892.32
750	0	513,825.40	263,084.83	19,660.98	15,520.70	507,847.93	1,319,939.84
760	0	865,919.50	145,078.66	400,671.60	50.84	25.82	1,411,746.41
770	0	139,157.33	47,625.10	12,904.97	477,477.55	37.14	677,202.09
780	0	43,843.64	110,689.41	1,796.26	1,675,679.67	5.17	1,832,014.15
800	0	129,907.39	16,446.62	8.96	6.87	8.43	146,378.28
810	0	381,297.75	125,301.87	4.65	139,114.73	4.38	645,723.38
820	0	47,846.22	7,689.04	0	147,705.50	0	203,240.76
830	0	75,190.64	29,044.69	121.42	506,074.84	0	610,431.60
840	0	0	370,591.83	0	2,181,566.16	0	2,552,158.00
850	0	168,416.66	7,721.16	248.98	0	161.16	176,547.95
860	0	51,548.69	15,235.60	952.42	0	0	67,736.71
870	0	0	2,664.92	139.43	1.81	32.76	2,838.92
880	0	0	9,516.72	390.19	5.06	91.66	10,003.63
890	0	49,601.26	1,827.46	170.19	1,358.08	0	52,956.98
900	0	0	1,567.10	0	0	21.65	1,588.76
910	0	15,514.91	53,885.24	1,231.42	21.14	25.99	70,678.70
920	0	62,955.97	524,769.97	9,776.78	341.18	2,303.15	600,147.05
930	0	503.09	18.59	0	0	0	521.67
940	0	0	41,268.62	4.25	0	36.1	41,308.97
950	0	0	0	0	0	0	0
960	0	18,457.87	534,848.19	0	0	0	553,306.06
970	0	32,294.00	298.98	104.79	0	0	32,697.76
980	0	14,810.76	21,283.14	488.61	1.17	1.28	36,584.96
990	0	5,781.55	47,539.75	882.86	30.13	249.89	54,484.19
	0	128,003,720.33	38,788,759.94	28,285,247.95	87,800,791.65	28,709,042.50	311,587,562.36

**Table H.2.9 Manure in Areas Susceptible to Run-off (BMPs possible)**

Model Segment	Cattle (lbs/yr)	Dairy (lbs/yr)	Swine (lbs/yr)	Poultry (layers) (lbs/yr)	Poultry (broilers) (lbs/yr)	Turkeys (lbs/yr)	TN Sus. Areas
							(BMP possible) (lbs/yr)
10	0	5,930,288.61	257,727.67	33.44	70.12	101.84	6,188,221.69
20	0	16,178,074.35	165,610.76	4,254.60	116.32	232.58	16,348,288.61
30	0	4,936,915.46	119,131.96	195.47	103.48	65.7	5,056,412.07
40	0	1,152,049.92	675,881.41	920.64	44,714.89	11,469.00	1,885,035.86
50	0	818,837.36	131,560.55	924.84	170.56	46.83	951,540.14
60	0	3,933,165.33	421,586.93	959.8	3,934.82	169.98	4,359,816.86
70	0	1,852,075.60	536,246.63	314.21	61,640.33	27,325.99	2,477,602.77
80	0	6,395,969.26	2,946,802.97	208,517.30	283,380.44	136,521.02	9,971,190.99
90	0	2,279,968.30	288,545.89	262.29	53.95	3,175.51	2,572,005.95
100	0	6,964,529.95	1,234,629.49	31,857.15	210,741.92	60,423.28	8,502,181.78
110	0	5,941,755.69	4,046,073.99	455,078.38	282,464.05	215,757.86	10,941,129.97
120	0	2,184,145.66	1,635,896.15	375,939.31	134,835.22	15,907.02	4,346,723.36
140	0	1,328,432.42	1,036,242.10	172,393.72	65,019.35	23,353.58	2,625,441.17
160	0	1,078,472.16	95,076.30	1,328.96	103,919.66	27,654.84	1,306,451.93
170	0	135,471.29	117,048.99	69,403.39	522,136.84	512,524.59	1,356,585.10
175	0	761,797.46	155,693.24	89,022.60	235,666.02	4,189.94	1,246,369.25
180	0	3,040,138.00	393,914.73	62,678.20	6,224.84	6,456.01	3,509,411.78
190	0	3,291,901.43	313,316.74	228,190.07	1,465,412.66	1,613,415.39	6,912,236.29
200	0	2,385,639.79	256,915.70	121,296.09	864,326.05	954,884.65	4,583,062.28
210	0	4,423,316.71	248,555.83	86,036.61	988.93	29,158.99	4,788,057.07
220	0	762,701.12	40,730.32	1,878.06	28.03	29.69	805,367.22
230	0	1,469,459.70	179,137.35	555.57	3,720.75	678.83	1,653,552.20
235	0	76,806.16	6,980.18	40.93	0	0	83,827.28
240	0	7,628.22	15,015.09	48.5	0	0	22,691.80
250	0	148,070.86	30,398.05	10.17	0	0	178,479.09
260	0	183,037.12	55,632.84	15.42	13,322.20	0.32	252,007.91
265	0	984.3	992.51	19.09	0	13,893.02	15,888.92
270	0	1,026,904.84	72,906.12	23,668.26	27,233.52	193,032.57	1,343,745.31
280	0	522,474.63	236,673.51	24,748.98	250,965.43	1,892.45	1,036,754.99
290	0	70,720.62	63,531.45	5,791.09	33,926.65	3.15	173,972.96
300	0	734,715.34	111,827.69	12,135.08	364,515.44	0	1,223,193.55
310	0	45,862.22	28,169.22	7.57	19,697.42	0	93,736.43
330	0	96,542.25	13,298.72	51.9	8.84	0	109,901.72
340	0	94,499.70	28,756.52	94.34	7.94	6.23	123,364.72
370	0	74,700.72	9,409.38	1.15	0.68	1.08	84,113.01
380	0	559,025.10	166,727.75	702.16	129,387.26	3.07	855,845.34
390	0	66,958.16	13,954.56	4	45,202.00	0	126,118.73
400	0	319,951.72	200,991.45	542.95	605,535.05	1.52	1,127,022.70
410	0	260,844.68	751,384.81	39,744.47	2,134,546.41	4.3	3,186,524.68
420	0	6,640.84	161,054.47	46,808.48	761,634.22	0	976,138.01
430	0	43,153.17	793,139.21	42,035.22	2,053,449.90	0	2,931,777.50
440	0	0	29,599.76	5.5	148,575.59	0	178,180.85
450	0	2,704,777.08	1,246,676.25	277,097.06	98,828.77	17,224.68	4,344,603.84
470	0	440,087.28	112,635.86	11,066.40	215.4	1,106.15	565,111.09
480	0	53,550.29	15,827.19	173.15	0	0	69,550.62
490	0	42,068.01	15,140.10	109.93	2.51	9.54	57,330.09
500	0	25,211.41	129,212.00	471.74	10.97	89.19	154,995.31

Model Segment	TN Sus. Areas						
	Cattle (lbs/yr)	Dairy (lbs/yr)	Swine (lbs/yr)	Poultry (layers) (lbs/yr)	Poultry (broilers) (lbs/yr)	Turkeys (lbs/yr)	(BMP possible) (lbs/yr)
510	0	0	2,369.06	21.69	0.28	5.1	2,396.13
540	0	46,395.02	13,338.87	82.48	4.11	0	59,820.48
550	0	420,259.72	10,623.51	183.49	8.8	12.79	431,088.31
560	0	24,731.34	54,773.11	49.55	0	0	79,554.00
580	0	16.63	0.61	0	0	0	17.25
590	0	198,037.61	109,490.50	66.97	6,746.80	2.61	314,344.49
600	0	3,515.79	1,138,821.56	207.16	36,959.61	0	1,179,504.12
610	0	26,991.54	8,451.69	10.37	3,400.41	0	38,854.00
620	0	271.15	342,106.54	0	27,003.82	0	369,381.52
630	0	3,687.70	3,149.44	0	62.81	0	6,899.95
630	0	0	0	0	0	0	0
700	0	915,454.30	18,033.75	5.44	4.7	4.77	933,502.96
710	0	1,978,043.36	1,537,005.16	323,302.82	119,661.82	20,003.59	3,978,016.76
720	0	5,766,036.82	4,271,642.72	1,006,014.85	368,981.83	30,563.87	11,443,240.09
730	0	3,692,893.51	1,161,249.19	133,315.60	29,834.45	25,123.07	5,042,415.83
740	0	2,382,823.38	851,293.79	36,301.85	2,412.17	1,220.40	3,274,051.59
750	0	411,060.32	210,467.86	2,752.54	2,172.90	71,098.71	697,552.33
760	0	692,735.60	116,062.93	56,094.02	7.12	3.61	864,903.28
770	0	111,325.87	38,100.08	1,806.70	66,846.86	5.2	218,084.70
780	0	35,074.92	88,551.53	251.48	234,595.15	0.72	358,473.80
800	0	103,925.91	13,157.30	1.26	0.96	1.18	117,086.61
810	0	305,038.20	100,241.50	0.65	19,476.06	0.61	424,757.02
820	0	38,276.98	6,151.23	0	20,678.77	0	65,106.98
830	0	60,152.52	23,235.75	17	70,850.48	0	154,255.75
840	0	0	296,473.47	0	305,419.26	0	601,892.73
850	0	134,733.33	6,176.93	34.86	0	22.56	140,967.67
860	0	41,238.95	12,188.48	133.34	0	0	53,560.77
870	0	0	2,131.94	19.52	0.25	4.59	2,156.30
880	0	0	7,613.38	54.63	0.71	12.83	7,681.55
890	0	39,681.01	1,461.97	23.83	190.13	0	41,356.93
900	0	0	1,253.68	0	0	3.03	1,256.71
910	0	12,411.93	43,108.20	172.4	2.96	3.64	55,699.12
920	0	50,364.78	419,815.98	1,368.75	47.77	322.44	471,919.71
930	0	402.47	14.87	0	0	0	417.34
940	0	0	33,014.90	0.59	0	5.05	33,020.54
950	0	0	0	0	0	0	0
960	0	14,766.29	427,878.55	0	0	0	442,644.85
970	0	25,835.20	239.18	14.67	0	0	26,089.05
980	0	11,848.61	17,026.51	68.41	0.16	0.18	28,943.87
990	0	4,625.24	38,031.80	123.6	4.22	34.98	42,819.85

**Table H.2.10 Manure in Areas Always Susceptible to Run-off**

Model Segment	Cattle (lbs/yr)	Dairy (lbs/yr)	Swine (lbs/yr)	Poultry (layers) (lbs/yr)	Poultry (broilers) (lbs/yr)	Turkeys (lbs/yr)	TN in Always Susceptible (lbs/yr)
10	0	1,482,572.15	64,431.92	2.39	5.01	7.27	1,547,018.74
20	0	4,044,518.59	41,402.69	303.9	8.31	16.61	4,086,250.10
30	0	1,234,228.86	29,782.99	13.96	7.39	4.69	1,264,037.90
40	0	288,012.48	168,970.35	65.76	3,193.92	819.21	461,061.73
50	0	204,709.34	32,890.14	66.06	12.18	3.35	237,681.07
60	0	983,291.33	105,396.73	68.56	281.06	12.14	1,089,049.82
70	0	463,018.90	134,061.66	22.44	4,402.88	1,951.86	603,457.74
80	0	1,598,992.32	736,700.74	14,894.09	20,241.46	9,751.50	2,380,580.11
90	0	569,992.08	72,136.47	18.74	3.85	226.82	642,377.96
100	0	1,741,132.49	308,657.37	2,275.51	15,052.99	4,315.95	2,071,434.31
110	0	1,485,438.92	1,011,518.50	32,505.60	20,176.00	15,411.28	2,565,050.30
120	0	546,036.42	408,974.04	26,852.81	9,631.09	1,136.22	992,630.56
140	0	332,108.10	259,060.53	12,313.84	4,644.24	1,668.11	609,794.82
160	0	269,618.04	23,769.08	94.93	7,422.83	1,975.35	302,880.22
170	0	33,867.82	29,262.25	4,957.38	37,295.49	36,608.90	141,991.84
175	0	190,449.36	38,923.31	6,358.76	16,833.29	299.28	252,864.00
180	0	760,034.50	98,478.68	4,477.01	444.63	461.14	863,895.97
190	0	822,975.36	78,329.19	16,299.29	104,672.33	115,243.96	1,137,520.12
200	0	596,409.95	64,228.93	8,664.01	61,737.58	68,206.05	799,246.50
210	0	1,105,829.18	62,138.96	6,145.47	70.64	2,082.78	1,176,267.03
220	0	190,675.28	10,182.58	134.15	2	2.12	200,996.13
230	0	367,364.92	44,784.34	39.68	265.77	48.49	412,503.20
235	0	19,201.54	1,745.05	2.92	0	0	20,949.51
240	0	1,907.05	3,753.77	3.46	0	0	5,664.29
250	0	37,017.72	7,599.51	0.73	0	0	44,617.96
260	0	45,759.28	13,908.21	1.1	951.59	0.02	60,620.20
265	0	246.08	248.13	1.36	0	992.36	1,487.92
270	0	256,726.21	18,226.53	1,690.59	1,945.25	13,788.04	292,376.62
280	0	130,618.66	59,168.38	1,767.78	17,926.10	135.17	209,616.10
290	0	17,680.16	15,882.86	413.65	2,423.33	0.22	36,400.22
300	0	183,678.83	27,956.92	866.79	26,036.82	0	238,539.37
310	0	11,465.55	7,042.31	0.54	1,406.96	0	19,915.36
330	0	24,135.56	3,324.68	3.71	0.63	0	27,464.58
340	0	23,624.93	7,189.13	6.74	0.57	0.44	30,821.80
370	0	18,675.18	2,352.34	0.08	0.05	0.08	21,027.73
380	0	139,756.28	41,681.94	50.15	9,241.95	0.22	190,730.53
390	0	16,739.54	3,488.64	0.29	3,228.71	0	23,457.18
400	0	79,987.93	50,247.86	38.78	43,252.50	0.11	173,527.19
410	0	65,211.17	187,846.20	2,838.89	152,467.60	0.31	408,364.17
420	0	1,660.21	40,263.62	3,343.46	54,402.44	0	99,669.73
430	0	10,788.29	198,284.80	3,002.52	146,674.99	0	358,750.60
440	0	0	7,399.94	0.39	10,612.54	0	18,012.88
450	0	676,194.27	311,669.06	19,792.65	7,059.20	1,230.33	1,015,945.51
470	0	110,021.82	28,158.96	790.46	15.39	79.01	139,065.64
480	0	13,387.57	3,956.80	12.37	0	0	17,356.74
490	0	10,517.00	3,785.03	7.85	0.18	0.68	14,310.74
500	0	6,302.85	32,303.00	33.7	0.78	6.37	38,646.70



Model Segment	Cattle (lbs/yr)	Dairy (lbs/yr)	Swine (lbs/yr)	Poultry (layers) (lbs/yr)	Poultry (broilers) (lbs/yr)	Turkeys (lbs/yr)	TN in Always Susceptible (lbs/yr)
510	0	0	592.26	1.55	0.02	0.36	594.2
540	0	11,598.75	3,334.72	5.89	0.29	0	14,939.66
550	0	105,064.93	2,655.88	13.11	0.63	0.91	107,735.46
560	0	6,182.84	13,693.28	3.54	0	0	19,879.65
580	0	4.16	0.15	0	0	0	4.31
590	0	49,509.40	27,372.63	4.78	481.91	0.19	77,368.91
600	0	878.95	284,705.39	14.8	2,639.97	0	288,239.11
610	0	6,747.88	2,112.92	0.74	242.89	0	9,104.43
620	0	67.79	85,526.63	0	1,928.84	0	87,523.27
630	0	921.92	787.36	0	4.49	0	1,713.77
630	0	0	0	0	0	0	0
700	0	228,863.57	4,508.44	0.39	0.34	0.34	233,373.08
710	0	494,510.84	384,251.29	23,093.06	8,547.27	1,428.83	911,831.29
720	0	1,441,509.21	1,067,910.68	71,858.20	26,355.84	2,183.13	2,609,817.07
730	0	923,223.38	290,312.30	9,522.54	2,131.03	1,794.51	1,226,983.76
740	0	595,705.85	212,823.45	2,592.99	172.3	87.17	811,381.75
750	0	102,765.08	52,616.97	196.61	155.21	5,078.48	160,812.34
760	0	173,183.90	29,015.73	4,006.72	0.51	0.26	206,207.11
770	0	27,831.47	9,525.02	129.05	4,774.78	0.37	42,260.68
780	0	8,768.73	22,137.88	17.96	16,756.80	0.05	47,681.42
800	0	25,981.48	3,289.32	0.09	0.07	0.08	29,271.04
810	0	76,259.55	25,060.37	0.05	1,391.15	0.04	102,711.16
820	0	9,569.24	1,537.81	0	1,477.05	0	12,584.11
830	0	15,038.13	5,808.94	1.21	5,060.75	0	25,909.03
840	0	0	74,118.37	0	21,815.66	0	95,934.03
850	0	33,683.33	1,544.23	2.49	0	1.61	35,231.66
860	0	10,309.74	3,047.12	9.52	0	0	13,366.38
870	0	0	532.98	1.39	0.02	0.33	534.72
880	0	0	1,903.34	3.9	0.05	0.92	1,908.21
890	0	9,920.25	365.49	1.7	13.58	0	10,301.03
900	0	0	313.42	0	0	0.22	313.64
910	0	3,102.98	10,777.05	12.31	0.21	0.26	13,892.82
920	0	12,591.19	104,953.99	97.77	3.41	23.03	117,669.40
930	0	100.62	3.72	0	0	0	104.33
940	0	0	8,253.72	0.04	0	0.36	8,254.13
950	0	0	0	0	0	0	0
960	0	3,691.57	106,969.64	0	0	0	110,661.21
970	0	6,458.80	59.8	1.05	0	0	6,519.64
980	0	2,962.15	4,256.63	4.89	0.01	0.01	7,223.69
990	0	1,156.31	9,507.95	8.83	0.3	2.5	10,675.89
	0	25,600,744.07	7,757,751.99	282,852.48	878,007.92	287,090.42	34,806,446.87

**Table H.2.11 Manure in Areas Never Susceptible to Run-off**

Model Segment	Cattle (lbs/yr)	Dairy (lbs/yr)	Swine (lbs/yr)	Poultry (layers) (lbs/yr)	Poultry (broilers) (lbs/yr)	Turkeys (lbs/yr)	TN in Non-Susceptible (lbs/yr)
10	0	0	0	203.03	425.75	618.3	1,247.08
20	0	0	0	25,831.48	706.23	1,412.12	27,949.82
30	0	0	0	1,186.78	628.28	398.91	2,213.96
40	0	0	0	5,589.58	271,483.28	69,633.24	346,706.10
50	0	0	0	5,615.07	1,035.53	284.35	6,934.96
60	0	0	0	5,827.35	23,889.97	1,032.02	30,749.34
70	0	0	0	1,907.73	374,244.89	165,907.79	542,060.40
80	0	0	0	1,265,997.89	1,720,524.12	828,877.59	3,815,399.61
90	0	0	0	1,592.49	327.58	19,279.88	21,199.95
100	0	0	0	193,418.38	1,279,504.51	366,855.64	1,839,778.52
110	0	0	0	2,762,975.85	1,714,960.30	1,309,958.44	5,787,894.60
120	0	0	0	2,282,488.66	818,642.41	96,578.31	3,197,709.38
140	0	0	0	1,046,676.16	394,760.37	141,789.57	1,583,226.10
160	0	0	0	8,068.68	630,940.82	167,904.40	806,913.90
170	0	0	0	421,377.72	3,170,116.54	3,111,756.46	6,703,250.72
175	0	0	0	540,494.33	1,430,829.38	25,438.93	1,996,762.64
180	0	0	0	380,546.23	37,793.68	39,197.20	457,537.10
190	0	0	0	1,385,439.68	8,897,148.31	9,795,736.29	20,078,324.28
200	0	0	0	736,440.53	5,247,693.90	5,797,513.95	11,781,648.39
210	0	0	0	522,365.14	6,004.21	177,036.72	705,406.06
220	0	0	0	11,402.49	170.19	180.28	11,752.96
230	0	0	0	3,373.12	22,590.27	4,121.49	30,084.88
235	0	0	0	248.52	0	0	248.52
240	0	0	0	294.45	0	0	294.45
250	0	0	0	61.76	0	0	61.76
260	0	0	0	93.65	80,884.76	1.94	80,980.36
265	0	0	0	115.88	0	84,350.48	84,466.36
270	0	0	0	143,700.13	165,346.38	1,171,983.49	1,481,030.00
280	0	0	0	150,261.66	1,523,718.66	11,489.86	1,685,470.17
290	0	0	0	35,160.19	205,983.23	19.11	241,162.53
300	0	0	0	73,677.27	2,213,129.47	0	2,286,806.74
310	0	0	0	45.98	119,591.49	0	119,637.47
330	0	0	0	315.14	53.65	0	368.79
340	0	0	0	572.78	48.19	37.82	658.8
370	0	0	0	6.99	4.14	6.57	17.7
380	0	0	0	4,263.11	785,565.53	18.62	789,847.26
390	0	0	0	24.29	274,440.71	0	274,465.01
400	0	0	0	3,296.49	3,676,462.83	9.25	3,679,768.58
410	0	0	0	241,305.68	12,959,746.09	26.12	13,201,077.89
420	0	0	0	284,194.33	4,624,207.77	0	4,908,402.10
430	0	0	0	255,213.86	12,467,374.41	0	12,722,588.27
440	0	0	0	33.36	902,066.08	0	902,099.45
450	0	0	0	1,682,375.00	600,031.80	104,578.41	2,386,985.21
470	0	0	0	67,188.88	1,307.80	6,715.89	75,212.57
480	0	0	0	1,051.24	0	0	1,051.24
490	0	0	0	667.41	15.25	57.9	740.55
500	0	0	0	2,864.12	66.61	541.5	3,472.24

Model Segment	Cattle (lbs/yr)	Dairy (lbs/yr)	Swine (lbs/yr)	Poultry (layers) (lbs/yr)	Poultry (broilers) (lbs/yr)	Turkeys (lbs/yr)	TN in Non-Susceptible (lbs/yr)
510	0	0	0	131.7	1.71	30.94	164.34
540	0	0	0	500.75	24.95	0	525.7
550	0	0	0	1,114.06	53.4	77.67	1,245.13
560	0	0	0	300.83	0	0	300.83
580	0	0	0	0	0	0	0
590	0	0	0	406.6	40,962.70	15.83	41,385.13
600	0	0	0	1,257.76	224,397.61	0	225,655.38
610	0	0	0	62.99	20,645.32	0	20,708.30
620	0	0	0	0	163,951.78	0	163,951.78
630	0	0	0	0	381.36	0	381.36
630	0	0	0	0	0	0	0
700	0	0	0	33.04	28.56	28.95	90.55
710	0	0	0	1,962,909.98	726,518.21	121,450.39	2,810,878.58
720	0	0	0	6,107,947.32	2,240,246.81	185,566.35	8,533,760.48
730	0	0	0	809,416.15	181,137.70	152,532.95	1,143,086.80
740	0	0	0	220,404.09	14,645.31	7,409.57	242,458.97
750	0	0	0	16,711.84	13,192.60	431,670.74	461,575.17
760	0	0	0	340,570.86	43.21	21.94	340,636.02
770	0	0	0	10,969.23	405,855.91	31.57	416,856.71
780	0	0	0	1,526.82	1,424,327.72	4.39	1,425,858.93
800	0	0	0	7.62	5.84	7.17	20.63
810	0	0	0	3.96	118,247.52	3.72	118,255.20
820	0	0	0	0	125,549.67	0	125,549.67
830	0	0	0	103.21	430,163.62	0	430,266.82
840	0	0	0	0	1,854,331.24	0	1,854,331.24
850	0	0	0	211.63	0	136.99	348.62
860	0	0	0	809.56	0	0	809.56
870	0	0	0	118.52	1.54	27.84	147.89
880	0	0	0	331.66	4.3	77.91	413.87
890	0	0	0	144.66	1,154.36	0	1,299.03
900	0	0	0	0	0	18.41	18.41
910	0	0	0	1,046.71	17.97	22.09	1,086.77
920	0	0	0	8,310.26	290	1,957.68	10,557.94
930	0	0	0	0	0	0	0
940	0	0	0	3.61	0	30.68	34.29
950	0	0	0	0	0	0	0
960	0	0	0	0	0	0	0
970	0	0	0	89.07	0	0	89.07
980	0	0	0	415.32	0.99	1.09	417.4
990	0	0	0	750.43	25.61	212.4	988.45
	0	0	0	24,042,460.76	74,630,672.90	24,402,686.12	123,075,819.78

#### **Section H.2.2.2.4 Manure Application to Pasturelands**

Within the Phase IV Watershed Model, it is assumed that all manure voided in unconfined areas occurs in pasturelands. Figure H.2.7 presents a flowchart of the calculations used to estimate the amount of nitrogen applied to these pasturelands. Manure application rates (pounds/acre/year) per Watershed Model segment are calculated by dividing the amount of manure voided in pasture by the number of pasture acres. Annual manure application rates are divided by 182.5 to calculate manure application rates on two day intervals. Tables H.2.12 and H.2.13 list manure nutrient application rates (on two-day and annual intervals) for total nitrogen per Watershed Model segment. Manure nitrogen applications are split between organic nitrogen and ammonia in a ratio of 55 to 45 percent (Reedy et. al., 1979; Donigian et al., 1991).

The application rate for each crop type per Watershed Model segment is determined from the Phase IV Watershed Model input deck to allow for the comparison between the amount of manure produced in collectible/confined areas and that applied to agricultural lands. Using the total acreage for each crop type (conventional tillage, conservation tillage, and hayland) and the respective application rates, total nutrients applied for a given crop type are calculated. Adding the three crop types together yields the total nutrients from manure applied to cropland within a Watershed Model segment. Figures H.2.8-H.2.10 illustrate the differences between the model manure application rates and the rates calculated from animal unit and mass balance information to each of the three crop types.

To determine the amount of manure produced in a Watershed Model segment that is available for collection and application to pasturelands, the following steps were taken. After manure acres are calculated, 25 percent of the total nitrogen applied to pasture and croplands is assumed to be volatilized. The remaining total nitrogen from both confined/properly stored and confined/improperly stored is assumed to be collected and applied to croplands.

An application rate is calculated from the manure mass balance for each crop type. This is primarily used as a comparison tool. An effort is made to create comparable nutrient application rates proportional to the original nutrient application rates and consistent with the acreage of a given crop type within a Watershed Model segment. An added difficulty is that some crop type application rates are zero. When an application rate is zero and excess manure needs to be applied, the application rate is determined by a proportion of nutrient application rates and crop type acreage. Manure application rates are then compared with actual input of total nitrogen from the Phase IV Watershed Model, based on a matrix that determines how much of a crop area receives the specific manure and fertilizer applications.

Within the Phase IV Watershed Model, pastureland plant uptake simulations can be completed with three simulation methods. These methods are Michaelis-Menton, yield based, and first order simulations. Michaelis-Menton is included in the Phase IV Watershed Model for forest simulation only. Beaulac and Reckhow (1982) suggest that pastureland nutrient export is more like forest than it is like cropland. In other words, the pasture has a greater assimilation potential for nutrients than does cropland. Because pasturelands are not being managed for nutrients like cropland and yield-based plant uptake is based on growing specific sized crops, the first order

**Figure H.2.7 Method Used To Estimate Nitrogen Applied To Pasture**

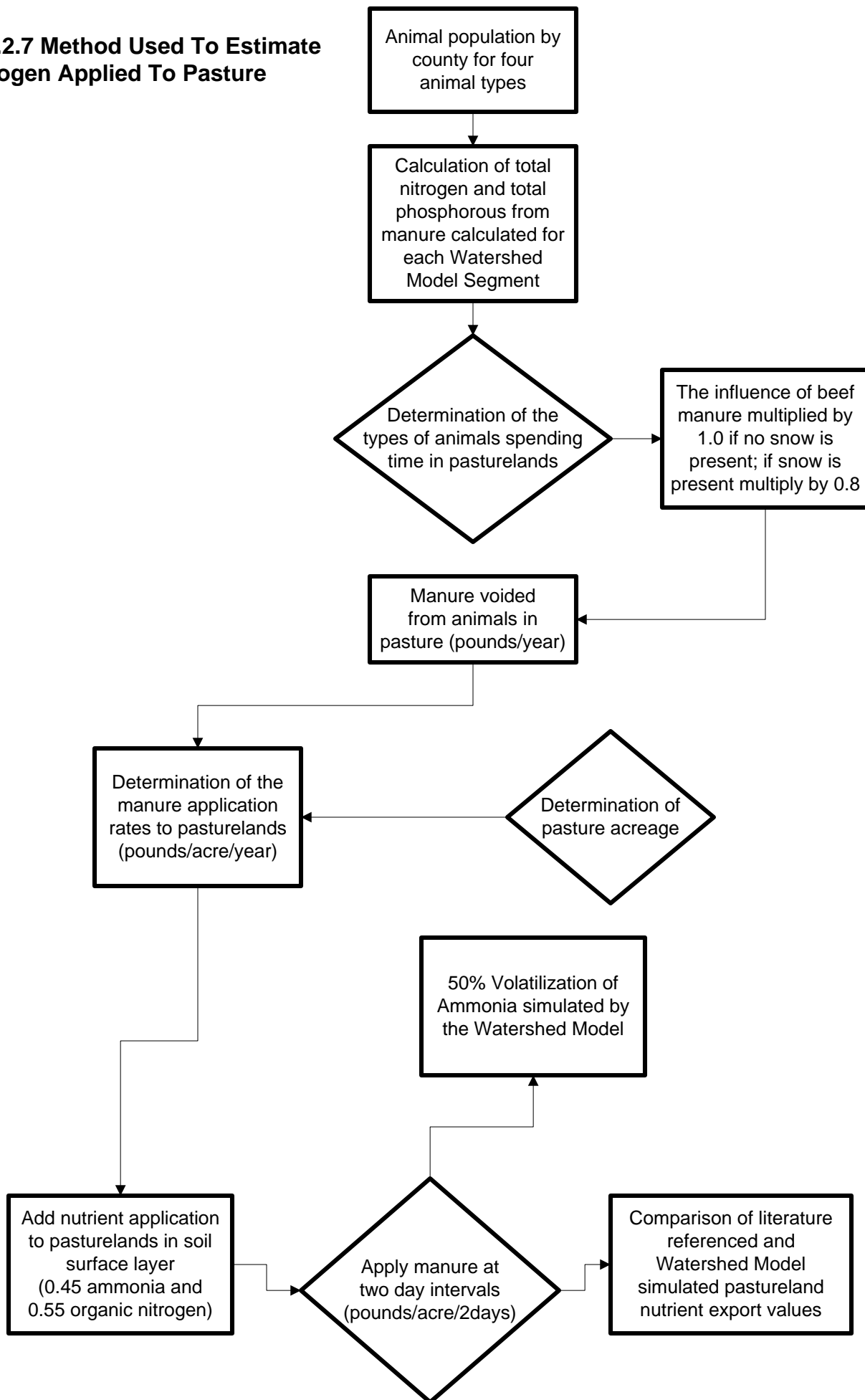

Table H.2.12 Breakdown Of TN Manure Applications Per 2 Days

Model Segment	Pasture Acres	NH3 lb/acre/2d	ORGN lb/acre/2d	TN lb/acre/2d
10	197241.72	0.038	0.046	0.084
20	427825.19	0.036	0.044	0.080
30	166774.57	0.046	0.057	0.103
40	82904.58	0.029	0.035	0.064
50	39209.33	0.040	0.049	0.088
60	113776.55	0.048	0.058	0.106
70	70540.14	0.047	0.058	0.105
80	131155.56	0.070	0.085	0.155
90	52940.01	0.057	0.070	0.128
100	113751.64	0.069	0.085	0.154
110	114828.17	0.109	0.133	0.242
120	13523.79	0.285	0.348	0.634
140	22488.55	0.124	0.152	0.276
160	96781.63	0.037	0.045	0.082
170	197544.80	0.035	0.042	0.077
175	86197.83	0.047	0.058	0.105
180	73980.78	0.078	0.095	0.173
190	262749.45	0.082	0.101	0.183
200	205106.91	0.076	0.092	0.168
210	64782.21	0.101	0.123	0.224
220	124718.34	0.053	0.065	0.118
230	262317.19	0.070	0.085	0.155
235	10596.44	0.076	0.093	0.170
240	6293.27	0.066	0.080	0.146
250	30485.59	0.082	0.100	0.182
260	38213.65	0.090	0.110	0.200
265	25312.86	0.027	0.033	0.061
270	206758.49	0.081	0.099	0.180
280	240132.88	0.072	0.088	0.160
290	25576.39	0.089	0.109	0.198
300	86827.25	0.068	0.083	0.150
310	2679.33	0.122	0.150	0.272
330	14447.08	0.033	0.040	0.072
340	12027.71	0.052	0.063	0.115
370	6447.03	0.026	0.032	0.057
380	31799.23	0.024	0.029	0.053
390	6639.97	0.019	0.024	0.043
400	26747.25	0.023	0.029	0.052
410	11302.76	0.081	0.099	0.179
420	2847.37	0.055	0.068	0.123
430	10118.39	0.059	0.073	0.132
440	2340.72	0.033	0.040	0.074
450	64410.66	0.084	0.103	0.188
470	37039.47	0.039	0.048	0.087
480	2561.81	0.078	0.095	0.173
490	2298.82	0.136	0.167	0.303
500	34407.79	0.018	0.022	0.039
510	984.28	0.061	0.075	0.136
540	2547.52	0.098	0.119	0.217
550	72686.55	0.053	0.064	0.117
560	24494.42	0.077	0.094	0.171
580	1221.64	0.030	0.036	0.066
590	26051.43	0.050	0.061	0.110
600	23684.19	0.076	0.093	0.169
610	6398.95	0.073	0.089	0.162
620	7267.65	0.034	0.042	0.076
630	314.71	0.046	0.056	0.102
650	13711.57	0.000	0.000	0.000
700	20243.34	0.104	0.127	0.231
710	16854.59	0.216	0.264	0.480
720	29341.79	0.340	0.416	0.756
730	32615.84	0.143	0.175	0.318
740	167395.31	0.049	0.059	0.108
750	14821.07	0.070	0.086	0.156
760	11514.92	0.161	0.196	0.357
770	4744.65	0.047	0.057	0.103
780	2706.72	0.043	0.053	0.097
800	4563.08	0.051	0.062	0.113
810	14539.95	0.027	0.033	0.060
820	2157.94	0.032	0.039	0.071
830	8020.67	0.018	0.022	0.040
840	2846.15	0.038	0.047	0.085
850	3714.99	0.116	0.141	0.257
860	873.63	0.176	0.215	0.391
870	1005.95	0.054	0.066	0.120
880	7333.31	0.030	0.037	0.068
890	2048.45	0.079	0.097	0.176
900	4631.52	0.023	0.029	0.052
910	8315.22	0.029	0.035	0.063
920	38156.70	0.022	0.026	0.048
930	1685.97	0.016	0.020	0.036
940	3284.16	0.080	0.097	0.177
950	1532.51	0.013	0.016	0.030
960	1514.33	0.059	0.072	0.131
970	1205.32	0.145	0.177	0.321
980	20204.74	0.055	0.068	0.123
990	1226.42	0.045	0.055	0.101
	<b>Average</b>	<b>0.069</b>	<b>0.084</b>	<b>0.153</b>

Table H.2.13 Breakdown Of TN Manure Applications Per Year

Model Segment	Pasture Acres	NH3 lb/acre/2d	ORGN lb/acre/2d	TN lb/acre/2d
10	197241.72	6.870	8.397	15.267
20	427825.19	6.579	8.042	14.621
30	166774.57	8.458	10.338	18.796
40	82904.58	5.227	6.388	11.615
50	39209.33	7.266	8.881	16.147
60	113776.55	8.698	10.631	19.329
70	70540.14	8.617	10.532	19.150
80	131155.56	12.692	15.512	28.203
90	52940.01	10.477	12.805	23.282
100	113751.64	12.637	15.445	28.082
110	114828.17	19.844	24.254	44.098
120	13523.79	52.033	63.596	115.629
140	22488.55	22.665	27.702	50.368
160	96781.63	6.770	8.275	15.045
170	197544.80	6.317	7.721	14.038
175	86197.83	8.637	10.556	19.194
180	73980.78	14.208	17.366	31.574
190	262749.45	15.052	18.397	33.450
200	205106.91	13.788	16.853	30.641
210	64782.21	18.364	22.445	40.809
220	124718.34	9.682	11.833	21.515
230	262317.19	12.762	15.598	28.361
235	10596.44	13.936	17.033	30.968
240	6293.27	11.997	14.663	26.660
250	30485.59	14.978	18.306	33.284
260	38213.65	16.455	20.111	36.566
265	25312.86	4.995	6.105	11.100
270	206758.49	14.759	18.039	32.798
280	240132.88	13.173	16.101	29.274
290	25576.39	16.271	19.886	36.157
300	86827.25	12.347	15.091	27.438
310	2679.33	22.355	27.323	49.678
330	14447.08	5.946	7.267	13.213
340	12027.71	9.418	11.511	20.929
370	6447.03	4.715	5.763	10.479
380	31799.23	4.334	5.297	9.631
390	6639.97	3.539	4.325	7.864
400	26747.25	4.256	5.201	9.457
410	11302.76	14.728	18.000	32.728
420	2847.37	10.119	12.368	22.487
430	10118.39	10.843	13.253	24.096
440	2340.72	6.042	7.385	13.427
450	64410.66	15.419	18.845	34.264
470	37039.47	7.150	8.738	15.888
480	2561.81	14.220	17.380	31.600
490	2298.82	24.872	30.399	55.272
500	34407.79	3.221	3.937	7.159
510	984.28	11.171	13.653	24.824
540	2547.52	17.831	21.794	39.626
550	72686.55	9.613	11.750	21.363
560	24494.42	14.054	17.177	31.231
580	1221.64	5.395	6.594	11.989
590	26051.43	9.043	11.053	20.096
600	23684.19	13.886	16.972	30.858
610	6398.95	13.321	16.282	29.603
620	7267.65	6.223	7.606	13.829
630	314.71	8.393	10.258	18.652
650	13711.57	0.000	0.000	0.000
700	20243.34	18.985	23.204	42.189
710	16854.59	39.397	48.152	87.549
720	29341.79	62.066	75.858	137.923
730	32615.84	26.149	31.960	58.109
740	167395.31	8.883	10.857	19.741
750	14821.07	12.774	15.613	28.387
760	11514.92	29.304	35.816	65.121
770	4744.65	8.496	10.384	18.879
780	2706.72	7.936	9.699	17.635
800	4563.08	9.294	11.360	20.654
810	14539.95	4.943	6.042	10.985
820	2157.94	5.822	7.116	12.938
830	8020.67	3.267	3.993	7.260
840	2846.15	6.962	8.509	15.471
850	3714.99	21.118	25.811	46.928
860	873.63	32.112	39.248	71.360
870	1005.95	9.836	12.022	21.858
880	7333.31	5.551	6.785	12.336
890	2048.45	14.432	17.639	32.071
900	4631.52	4.284	5.235	9.519
910	8315.22	5.203	6.359	11.563
920	38156.70	3.938	4.813	8.751
930	1685.97	2.942	3.596	6.538
940	3284.16	14.545	17.778	32.323
950	1532.51	<b>2.425</b>	<b>2.964</b>	<b>5.388</b>
960	1514.33	10.757	13.147	23.904
970	1205.32	26.399	32.266	58.665
980	20204.74	10.125	12.375	22.499
990	1226.42	8.271	10.109	18.381
	<b>Average</b>	12.562	15.353	27.915

**Figure H.2.8 Comparison of Modeled and Observed Manure Application Rates of TN to Conventional Tillage**

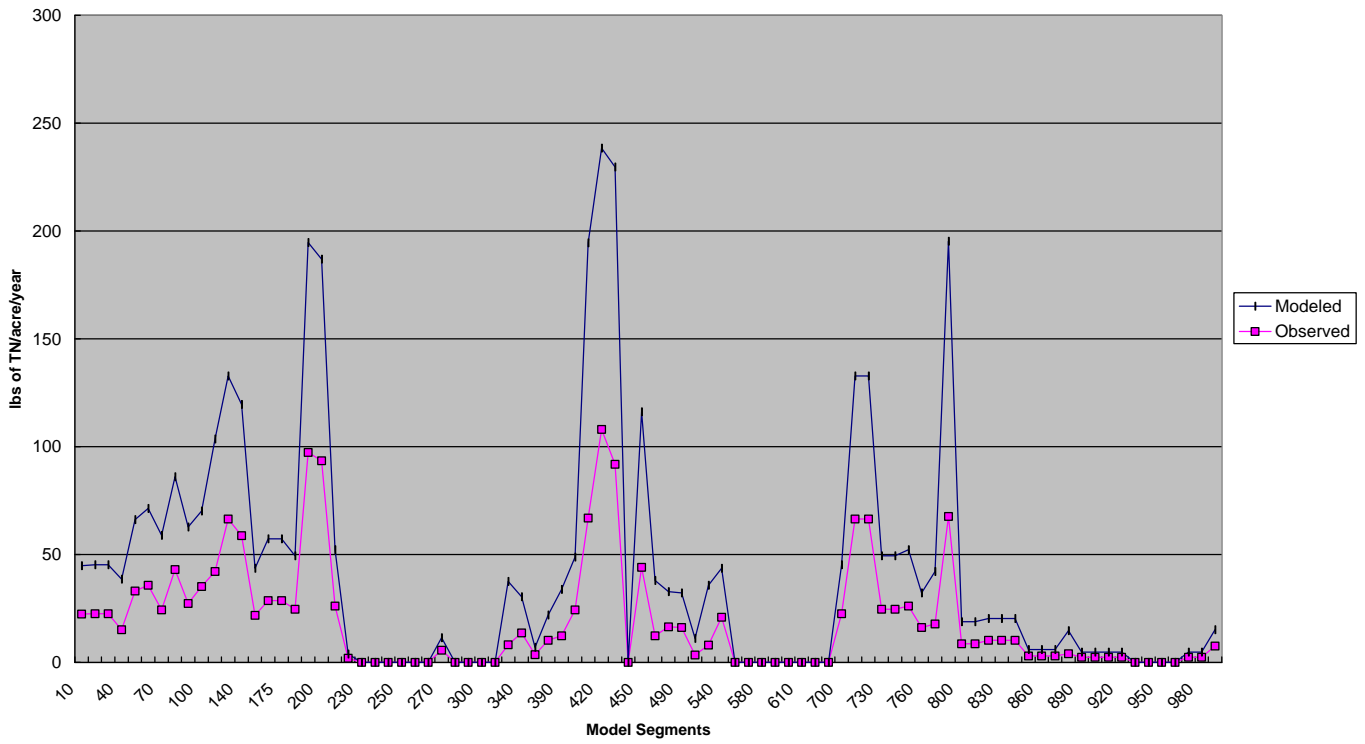

**Comparison of Modeled and Observed Manure Application Rates of TP to Conventional Tillage**

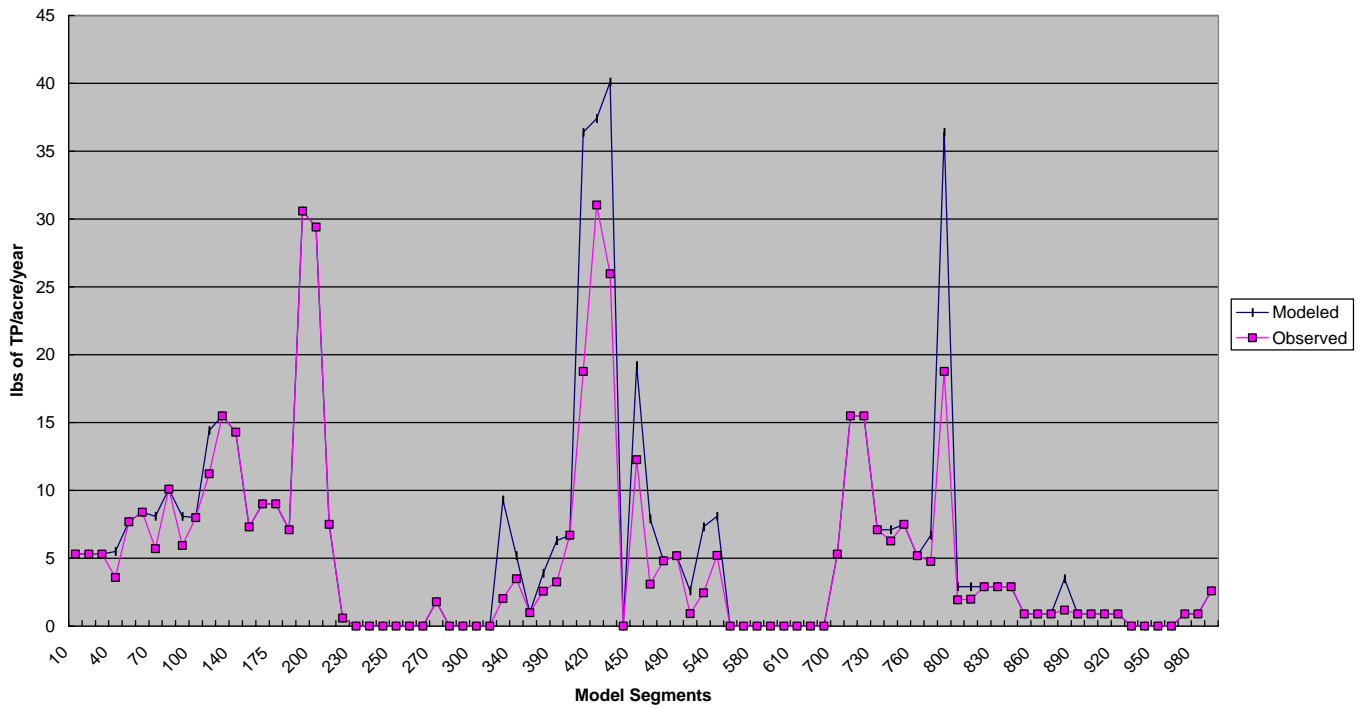



**Figure H.2.9 Comparison of Modeled and Observed Manure Application Rates of TN to Conservation Tillage**

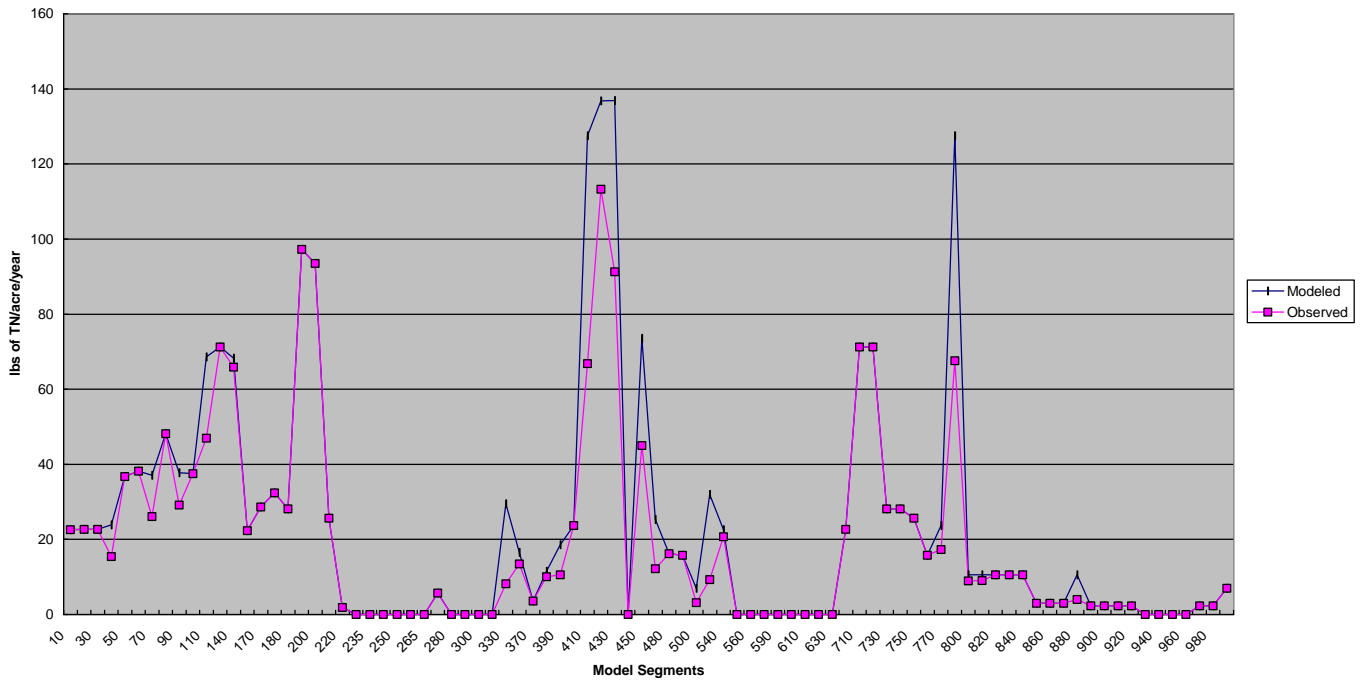

**Comparison of Modeled and Observed Manure Application Rates of TP to Conservation Tillage**

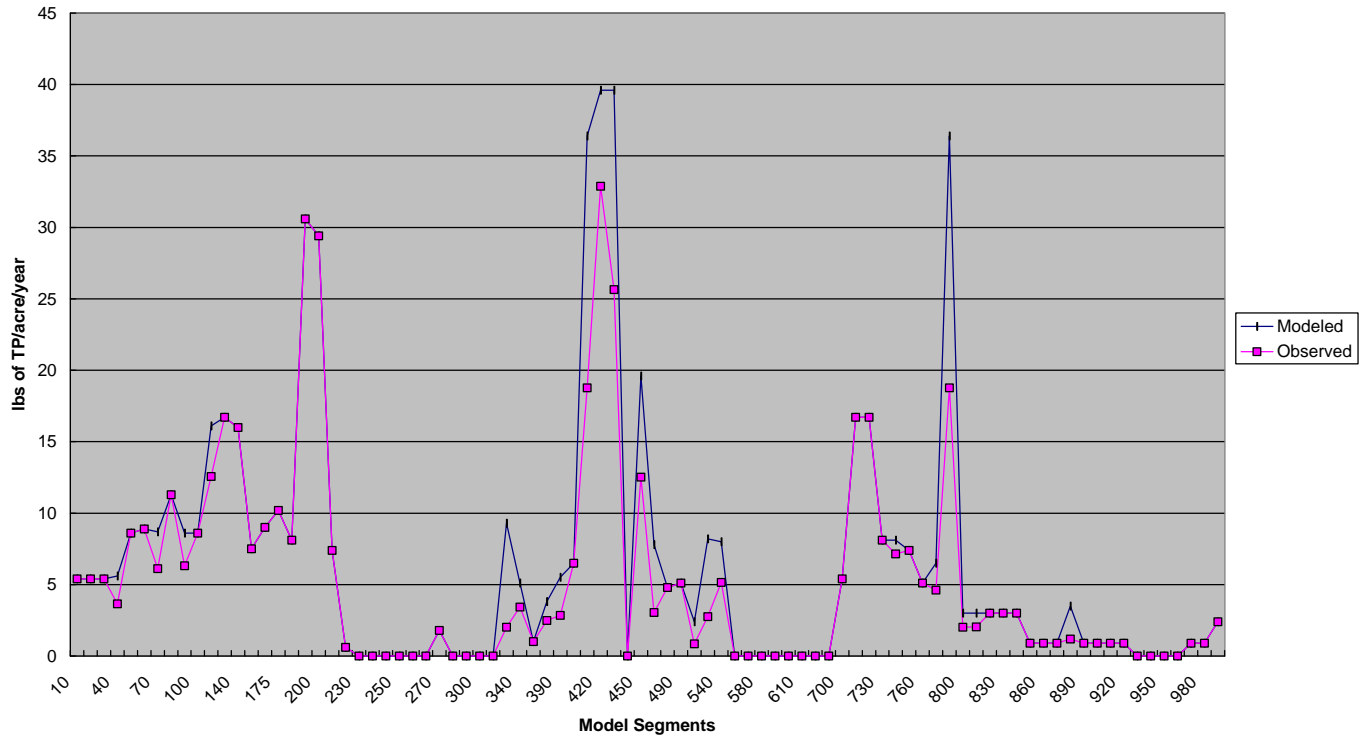
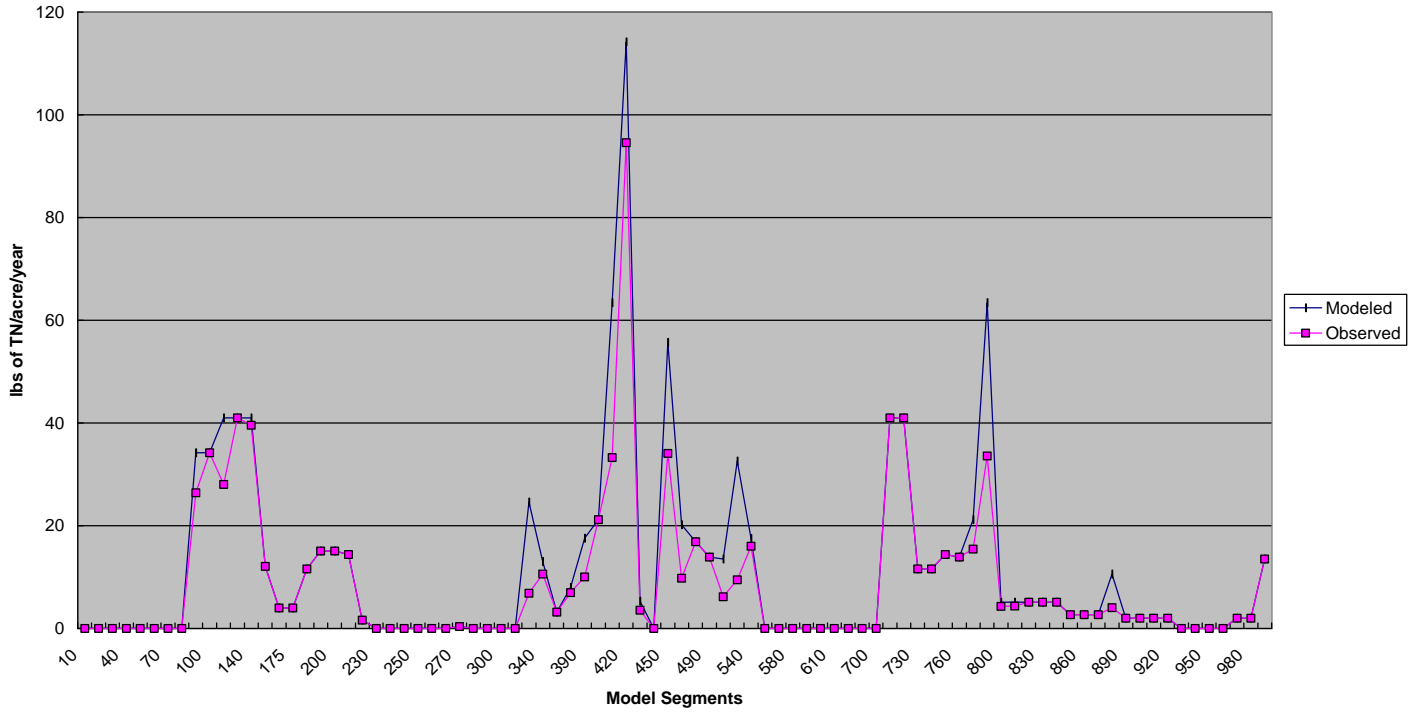
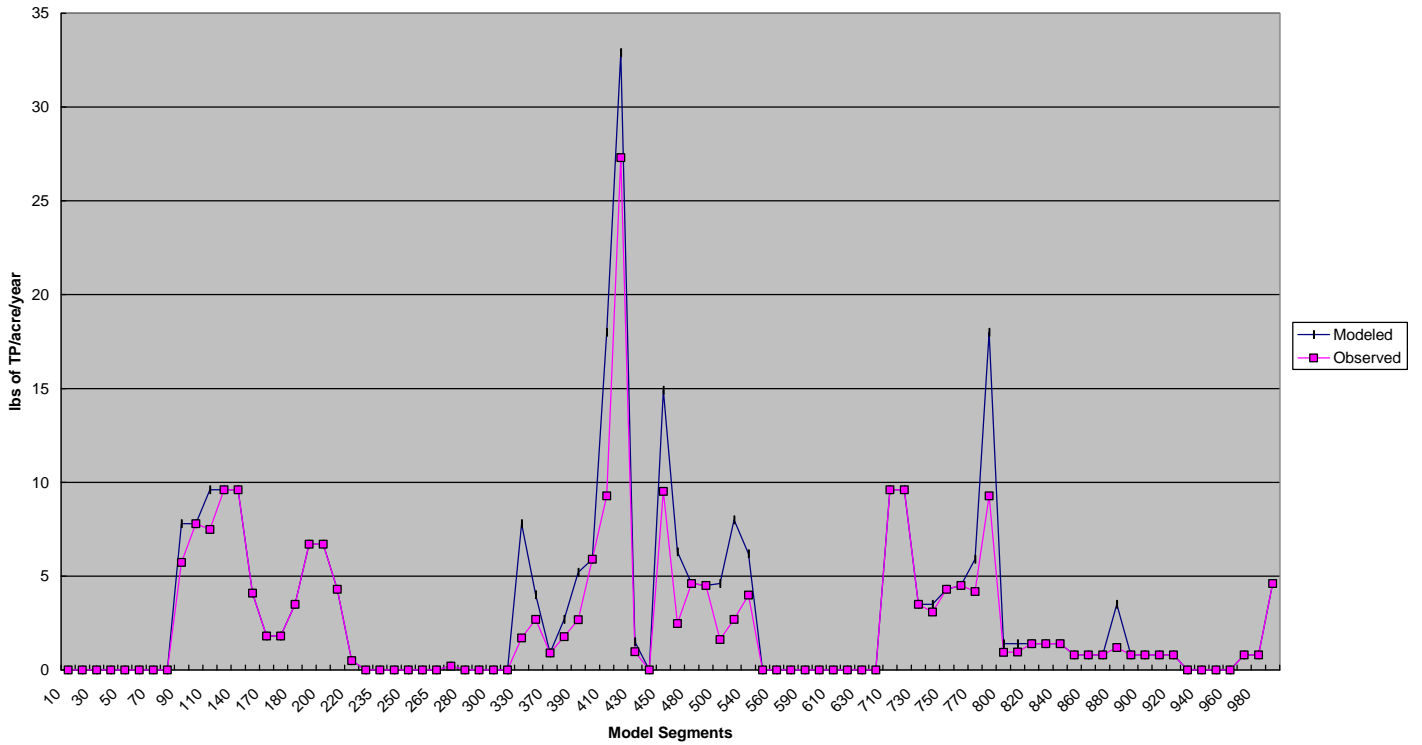

Figure H.2.10 Comparison of Modeled and Observed Manure Application Rates of TN to Hayland



Comparison of Modeled and Observed Manure Application Rates of TP to Hayland



simulation method seems to be the most appropriate for the simulation of plant uptake within pasturelands.

The amounts of manure nutrients applied to pasturelands are incorporated into the Phase IV Watershed Model using AGCHEM Watershed Model input files. Ammonia volatilization rates for manured pasturelands are simulated by the Phase IV Watershed Model and are based on a 50 percent loss of ammonia in the first twenty-four hours for unincorporated manure (Thompson et al. 1987, Lauer et al. 1976, and Reedy et al. 1979b). After five days only 3 percent of the original ammonia is retained. The surface layer ammonia volatilization rate is lower than the sub-surface layer ammonia volatilization rate and is based on a 40 percent volatilization loss after ten days. Lower layers down to and including groundwater layers simulated within the Phase IV Watershed Model have no ammonia volatilization due to the incorporation of manure into the soil.

#### **Section H.2.2.2.5 Runoff Control for Animal Confinement Areas**

A facility with an existing animal waste storage structure may not have runoff controls for animal confinement areas. As a result, runoff from up-slope areas and roof flows to feedlots can carry waste nutrients to surface water bodies. In some cases, excess runoff flows into waste lagoons cause overflow problems. Animal confinement runoff control consists of practices such as up-slope diversions and directed downspouts to minimize off-site water entering the facility. In some cases, improved conditions at the confinement facility can improve animal health and production. Both supplemental and full runoff control systems are monitored by the signatory states. Supplemental systems are those installed in addition to a waste storage structure and full systems are installed at a site without a preexisting storage structure.

Implementation of a full system (without a waste storage system) reduces current nutrient loads by an estimated 75 percent for nitrogen, phosphorus, and sediment. A supplemental system (with a waste storage system) can reduce current nutrient loads by an additional 10 percent for nitrogen, phosphorus, and suspended sediment beyond those reductions gained by the storage structure.

#### **Section H.2.2.2.6 Grazing Land Rotation**

The rotation of livestock on grazing land limits the manure load and other impacts of livestock to pasture. Benefits of this BMP include improved infiltration/runoff characteristics, healthier grass stands, reduced need for fertilizers, and reduced erosion. It is estimated that the nitrogen and phosphorous load is reduced by 50 percent and suspended sediment loads are reduced by 25 percent for pastures utilizing grazing rotation management. See the Stream Protection paragraphs (below) for an explanation of how this BMP is incorporated into the pasture.

#### **Section H.2.2.2.7 Stream Protection (with and without fencing)**

Direct animal contact with surface waters and the resultant streambank erosion are primary causes of nutrient loss from pastures. Stream protection with fencing involves fencing narrow strips of land along streams to exclude livestock. The fenced areas may be planted with trees or grass, but are typically not wide enough to provide the benefits of buffers. The implementation

of stream fencing limits the length of streambanks where animals can enter into a stream but does not exclude animals from entering the stream within limited watering and stream crossing areas.

Streambank fencing greatly reduces the nutrient losses from pasture, in addition to improving streambank stability, reducing sedimentation, and creating wildlife habitat. The implementation of two hundred and eight feet of streambank fencing results in a nutrient reduction equal to 75 percent of the load from three acres of pasture.

Stream protection without fencing involves the use of troughs or “water holes” away from streams. In some instances, trees are planted away from the stream to provide shade for the livestock. Research has indicated that these measures will greatly reduce the time livestock spend in streams. Therefore, nutrient losses should decrease.

The incorporation of stream protection (both with and without fencing) into the Phase IV Watershed Model involves a reduction of the load from pasture. To determine the total amount that the load to pasture is reduced for the entire Watershed Model segment, “Pastureland,” a new pasture application load, is incorporated in the SPEC-ACTIONS section of the Phase IV Watershed Model input deck.

It has been determined by the Chesapeake Bay Program Nutrient Subcommittee’s Tributary Strategy Workgroup that stream protection with fencing reduces nutrient and suspended sediment loads to pasture by 75 percent for total nitrogen, total phosphorous, and total suspended sediment. For stream protection without fencing the reduction is an estimated 40 percent for total nitrogen, phosphorous, and sediments. These reductions are only applied to pasturelands within the Phase IV Watershed Model.

#### **Section H.2.2.2.8 Forestry BMPs**

Forestry BMPs focus on minimizing the environmental impacts from forest harvesting operations, such as road building, and harvesting and thinning operations. These BMPs reduce soil erosion and the loss of nutrients that adhere to the eroding soil particles. Timber harvesting is a regulated activity. Additional controls are required when working in non-tidal wetlands, stream buffers, and the Chesapeake Bay Critical Area in Maryland. Forest harvesting BMPs could potentially be applied to all forested lands cut for timber each year. Virginia has a silviculture law that applies to the entire state.

Forest BMPs are incorporated into the Phase IV Watershed Model by reducing the nutrient and suspended sediment flow from the forest. It has been determined by the Chesapeake Bay Program Nutrient Subcommittee’s Tributary Strategy Workgroup that when BMPs are used during forest harvesting operations a reduction of 50 percent of total nitrogen, total phosphorus, and total suspended sediment loading is achieved.

### **Section H.2.2.2.9 Forest and Grass Buffers**

Forest and grass buffers also receive nutrient reduction efficiencies. For forested buffers, the average reduction for nitrogen is estimated to be 57 percent, and an estimated 70 percent reduction for phosphorous and suspended sediment. Grass buffers have an average nutrient reduction estimated at 43 percent for nitrogen and 53 percent for phosphorous and sediment.

### **Section H.2.2.2.10 Cover Crops**

This BMP refers to (non-harvested) cover crops specifically designed for nutrient removal. This BMP is more prevalent in the lower Chesapeake Basin due to the longer growing season. Significant amounts of nitrogen may remain in the soil after harvest, regardless of yield, especially during drought years. Nitrate nitrogen is particularly subject to leaching to groundwater over the winter if substantial amounts are in the soil in the fall. Small grains (i.e., rye, barley, wheat) planted without fertilizer in late summer or early fall will greatly reduce nitrate leaching losses. These small grains use the nitrogen as they grow, provided root growth is sufficient to reach the available nitrogen, hence the early planting date requirement. (Proper timing of cover crop plow-down in spring releases “trapped” nitrogen for use by the following crop.) As with other cover crops, their use reduces phosphorus losses through reduced soil erosion.

While nutrient reduction is the principal benefit of cover crops, the quality of the soil may also improve in the long-term. Cover crop acres will be assumed to be in the conventional and conservation tillage land uses, and will receive average reductions of 43 percent for nitrogen and 15 percent for phosphorus and sediment.

### **Section H.2.2.3 BMPs Affecting Direct Loads to Tidal Bay Waters**

Within the Phase IV Watershed Model, the types of BMPs affecting direct nutrient and suspended sediment loading to the Chesapeake Bay are marine pumpouts, tidal shoreline protection (structural and nonstructural), and combined sewer overflows (treatment and conversions). These BMPs reduce nutrient loads that are used as direct input into the Chesapeake Bay Water Quality Model.

#### **Section H.2.2.3.1 Marine Sewage Disposal Facilities**

Marine sewage disposal facilities include pumpouts and portable toilet dump stations located shore side to allow boaters to properly dispose of sewage. Boat sewage is then transported to local wastewater treatment plants, where treatment levels vary. Marine sewage pumped to local treatment plants is included in point source calculations. Only Maryland tracks marine pumpouts as part of their individual tributary strategies. Two components of controlling nutrients from boat waste are the installation of pump-out facilities and the implementation of an educational program to encourage boaters to use existing and new pumpouts for boat waste disposal. Marine sewage disposal facilities reduce the nitrogen load by an estimated 43 percent and the phosphorus and suspended sediment loads by an estimated 53 percent. Currently, nutrient reductions from these practices are not simulated by the Phase IV Watershed Model, but are subtracted from the final simulated Watershed Model output values.

### **Section H.2.2.3.2 Shoreline Protection**

Tidal structural and non-structural erosion control measures stabilize the eroding shoreline, a major source of suspended sediment and nutrient loading to the Bay. Non-structural erosion control practices focus on the use of native vegetation to stabilize shorelines. Where wave energy is too high for the non-structural approach, structural methods are employed, such as stone revetments and breakwaters. Both tidal structural and non-structural erosion controls reduce the nitrogen, phosphorus, and suspended sediment loads by an estimated 75 percent. Similar to marine sewage disposal facility pumpouts, nutrient reductions from shoreline erosion practices are not simulated by the Phase IV Watershed Model but are subtracted from final simulated load output values.

### **Section H.2.2.3.3 Combine Sewer Overflows**

Combined sewer overflows (CSOs) deliver a nutrient load to rivers and the bay during storm events. A combined sewer system only uses a single sewer pipe network to collect storm runoff, domestic wastewater, and industrial discharge. During dry-weather flow periods, the wastewater treatment facility is able to process all dry weather flows. However, during storm events, the wastewater treatment facility is unable to handle the increased flow; therefore, the excess flow (containing sewage) is discharged directly into the water bodies through a bypass mechanism in the conveyance system. Since high loads are a result of high flow periods, the combined sewer overflow is extremely detrimental to nutrient reduction strategies. There is an effort to treat water that does originate during a high flow period. Conversion of combined sewer overflows is one effort underway to reduce nutrient loads to the tributary rivers and the Bay. The treatment and conversion of combined sewer overflows are tracked in the tributary reductions. Treatment of combined sewer overflows reduce the nitrogen load by an estimated 15 percent and the phosphorus and suspended sediment loads by an estimated 30 percent. Conversion of combined sewer overflows reduce the nitrogen, phosphorus, and suspended sediment loads by an estimated 95 percent. This number is high because it is the assumed efficiency of wastewater treatment plants. To apply this load reduction in a Tributary Strategy Watershed Model Scenario, the existing combined sewer overflow load must be incorporated into the Water Quality Model (Note, to date this has only been done for the District of Columbia's combined sewer overflows).

### Section H.3 SUMMARY OF WATERSHED MODEL OPERATIONS

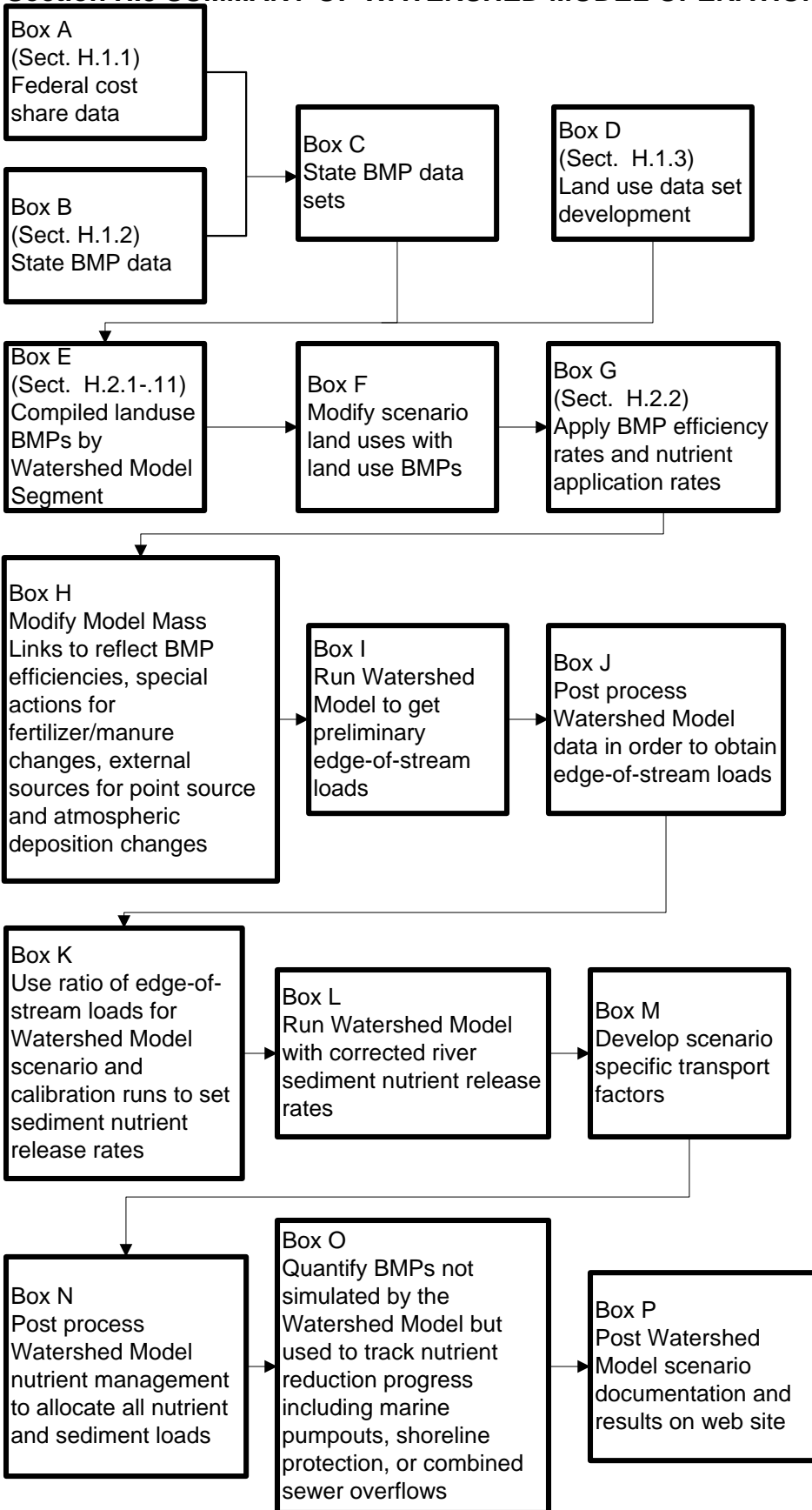

The Phase IV Watershed Model is based upon the Hydrologic Simulation Program-FORTRAN (HSPF) Model – Version 11 (Johanson et al., 1980). An HSPF simulation requires two types of data files, a user control input file (UCI) and a water data management (WDM) file. The UCI file contains simulation time and output control information, hydrological and nutrient dynamic module control, initialization, parameterization, linkages between land and water and specific loading information. The WDM file is a binary file that contains input time series data for meteorological, precipitation, atmospheric deposition and point source data.

Each scenario uses unique UCI files that are modifications of the reference scenario UCI files. The changes in the UCI files reflect the physical changes in the watershed due to estimated land use change and reported BMP implementation. A series of FORTRAN programs read each HSPF UCI file and generate modified files according to scenario-specific data files. All scenarios use the same WDM files.

### **Section H.3.1 Scenario Characteristic Modification**

For each scenario, the reference UCI files are modified by a series of FORTRAN programs. A UNIX script file is used to call each program in turn for each UCI. The modifications include land use changes, loads of fertilizer and manure to crop land, manure deposited on pasture land, changes to exported loads due to BMP implementation, and changes to point source and septic loads.

### **Section H.3.2 Initial Model Run for the Edge of Stream Loads**

After the synthesis of the scenario-specific UCI files is completed, a model run is performed to produce edge-of-stream loads. The output of this model run contains daily edge-of-stream loads for suspended solids and several species of nitrogen and phosphorus for each land use and model segment.

### **Section H.3.3 Adjustment of Bed Concentration**

The Phase IV Watershed Model adjusts the concentration of adsorbed ammonia and phosphate in the bed sediment of the free-flowing rivers. This adjustment is proportional to the change in edge-of-stream loading from all upstream sources for each particular Watershed Model segment. These factors are determined through the comparison of the Watershed Model Reference scenario edge-of-stream loads and those of the specific scenario being run. Once again, a FORTRAN program is used to automatically adjust the concentrations sorbed to bed sediment specified in the UCI files. Sediment scoured from the river bed is reduced by a similar process.

### **Section H.3.4 Second Model Run**

The second run of the Watershed Model scenario is only necessary for those model segments that have reaches, since the only alteration since the initial run is in the bed concentration and the amount of sediment scoured. The in-stream concentration files are then used to determine the loads for each reach that are delivered to the next downstream reach.



### **Section H.3.5 Delivery Factors**

To determine the loads delivered to the Chesapeake Bay from each source within each Phase IV Watershed Model segment, delivery factors must be developed which give the fraction of the total load entering any particular river reach that reaches tidal waters. A pre-formatted spreadsheet is used to calculate the delivery factors from the post-processed edge-of-stream loads and the loads exiting each reach.

### **Section H.3.6 Final Model Run**

This model run is a twelve year simulation that applies a nutrient load to the Chesapeake Bay Water Quality Model. The adjusted bed concentrations from the second run are used to simulate the full twelve years, as opposed to only eight. There are a few differences between this Phase IV Watershed Model run and the previous ones: (1) the November, 1985 storm is now included in the precipitation and load data, and (2) particulate inorganic phosphorus loads are now identified for linkage to the Chesapeake Bay Water Quality Model.

The final model outputs are in a tabular format with loading information about  $\text{NH}_3$ ,  $\text{NO}_3$ , organic nitrogen, total nitrogen,  $\text{PO}_4$ , organic phosphorus, total phosphorus, and total sediment. This information is further broken down by land use, basin, state and above/below fall line. Subsegmentation is used in segments that discharge directly to tidal waters. This produces higher resolution which is more compatible with the Water Quality Model.

## REFERENCES

- Beaulac, M.N. and K.H. Reckhow. 1982. An Examination Of The Land Use-Nutrient Export Relationship. *Water Resources Bulletin* 18(6): 1013-1024.
- Brown, K.W. and J.C. Thomas. 1978. Uptake of N by grass from septic fields in three soils. *Agronomy Journal*, 70: 1037-1040.
- Donigian, A.S. Jr., Linker, L.C., C. Chang. 1991. Chesapeake Bay Program Watershed Model Application To Calculate Bay Nutrient Loadings: Final Findings and Recommendations, U.S. Environmental Protection Agency, Annapolis, Maryland.
- Evanylo, G.K.. 1995. Mineralization And Availability Of Nitrogen In Organic Waste-Amended Mid-Atlantic Soils, STAC Literature Synthesis, CRC Publication, Edgewater, Maryland.
- Gilbertson, C.B. (Ed.). 1979. Animal Waste Utilization On Cropland And Pastureland: A Manual For Evaluating Agronomic And Environmental Effects, U.S. Department of Agriculture and U.S. Environmental Protection Agency.
- Graves, R.E. 1986. Field Application of Manure: A Supplement To Manure Management For Environmental Protection. Commonwealth of Pennsylvania, Department of Environmental Resources, Harrisburg, Pennsylvania.
- Haith, D.A. and L.L. Shoemaker. 1987. Generalized Watershed Loading Functions For Streamflow Nutrients. *Water Resources Bulletin* 23(3):471- 478.
- Johnson, T.J. and J.C. Parker. 1993. A Model Of Nitrate Leaching From Agricultural Systems In Virginia's Northern Neck. Virginia Water Resources Research Center, Virginia Polytechnic Institute and State University, Blacksburg, Virginia.
- Krider, J.N (Ed.). 1992. Agricultural Waste Management Handbook. National Engineering Handbook, United States Department of Agriculture, Soil conservation Service.
- Lauer, D.A., D.R. Bouldin, and S.D. Klausner. 1976. Ammonia Volatilization From Dairy Spread On The Soil Surface. *Journal of Environmental Quality* 5:134-141.
- Maizel, M.S., G. Muehlbach, P. Baynham, J. Zoerkler, D. Monds, T. Iivari, P. Welle, J. Robbin, J. Wiles. 1997. The Potential For Nutrient Loading From Septic Systems To Ground And Surface Water Resources And The Chesapeake Bay. Report of the Chesapeake Bay Program Office, Annapolis, MD.
- Novotny, V. and H. Olem. 1994. Water Quality: Prevention, Identification, And Management Of Diffuse Pollution. 311-332. Van Norstrand Reinhold, New York.
- Palace, M.W. 1997. An Animal Waste Nutrient Mass Balance For The Chesapeake Bay Watershed Model. Coastal Zone 97, Boston, Massachusetts. July 19-25, 1997.
- Reedy, K.R., R. Khaleel, M.R. Overcash, and P.W. Westerman. 1979a. A Nonpoint Source Model For Land Areas Receiving Animal Waste: Ammonia Volatilization. *Trans. ASAE* 22(6): 1398-1405.
- Reedy, K.R., R. Khaleel, M.R. Overcash, and P.W. Westerman. 1979b. A Nonpoint Source Model For Land Areas Receiving Animal Waste: Mineralization of Organic Nitrogen. *Trans. ASAE* 22(4): 863-872.
- Ritler, W.F. and J.N. Scarborough. 1996. An Evaluation Of Animal Waste Management Systems And Nutrient Management Strategies For The Chesapeake Bay; Cooperative Agreement.
- Robertson, W.D., J.A. Cherry, and E.A. Sudicky. 1991. Ground-water contamination from two small septic systems on sand aquifers. *Groundwater*, 29(1): 82-92.

Robertson, W.D. and J.A. Cherry. 1992. Hydrogeology of an unconfined sand aquifer and its effect on the behavior of nitrogen from a large-flux septic system. *Applied Hydrogeology*, pp. 32-44.

Robillard, P.D. and K.S. Martin. 1990a. Septic Tank Pumping. The Pennsylvania State University, College of Agricultural Sciences-Cooperative Extension. F-162.

Robillard, P.D. and K.S. Martin. 1990b. Preventing On-lot Septic System Failures. The Pennsylvania State University, College of Agricultural Sciences-Cooperative Extension. SW- 163.

Salvato, J.A. 1982. *Environmental Engineering And Sanitation (Third Edition)*. Wiley-Interscience, New York, New York.

Thompson, R.B., J.C. Ryden, and D.R. Lockyer. 1987. Fate Of Nitrogen In Cattle Slurry Following Surface Application Injection To Grassland. *Journal of Soil Science*, 38: 689-700.

This report is cited in the following way:  
Palace, M.W., J.E. Hannawald, L.C. Linker, and G.W. Shenk. 1998.  
Chesapeake Bay Watershed Model Applications & Calculation Of  
Nutrient & Sediment Loadings - Appendix H: Tracking Best  
Management Practice Nutrient Reductions in the Chesapeake Bay  
Program Report of the Modeling Subcommittee. August, 1998.  
Chesapeake Bay Program Office, Annapolis, MD.  
<http://www.chesapeakebay.net/modsc.htm> - *Publications Tab*. Date  
Retrieved: *retrieval date*